

**Lauper Instruments AG**  
Irisweg 16 B  
CH-3280 Murten  
Tel. +41 26 672 30 50  
info@lauper-instruments.ch  
www.lauper-instruments.ch

# TIGER<sup>LT</sup>

## Instrument User Manual V1.8R

---



Register  
your instrument online  
to receive your  
extended Warranty.

Unrivalled Gas Detection<sup>ion</sup>.

## **Register your instrument online for extended warranty**

Thank you for purchasing your ION Science instrument.

The standard warranty of your instrument can be extended to two years.

To receive your extended warranty, you must register your instrument online within one month of purchase (terms and conditions apply.)

## Warning

<b>USER MANUAL:</b>	Read and understand this user manual completely before operating the PhoCheck Tiger instrument.
<b>STATIC HAZARDS:</b>	Do not use abrasive or chemical detergents to clean the PhoCheck Tiger instrument as this may reduce the antistatic properties of the materials used, clean it using a damp cloth only.
<b>MATERIAL EXPOSURE:</b>	The PhoCheck Tiger must not be exposed to atmospheres known to have an adverse effect on Thermoplastic polyolefin or Anti-static PC/ABS.
<b>SERVICING:</b>	Do not remove the sensor cover in the hazardous area. No part of the PhoCheck Tiger may be opened in a hazardous area except for replacement of the battery pack. The PhoCheck Tiger must be serviced in a Non Hazardous environment and by Ion Science authorised service centres only. Do not service the instrument live. Remove battery pack before servicing. Substitution of components may impair intrinsic safety.
<b>BATTERY CHARGING:</b>	Charge PhoCheck Tiger and its lithium ion battery packs in a Non Hazardous environment only.
<b>BATTERY REPLACEMENT:</b>	Never replace primary Alkaline battery cells while in a potentially explosive or hazardous location. Use only Industrial by Duracell ID1500 batteries.
<b>BATTERY CONNECTION:</b>	The PhoCheck Tiger's lithium ion and alkaline battery packs have been specially designed to allow connection to the PhoCheck Tiger Instrument while in potentially hazardous atmospheres. Ensure all electrical connections are clean and undamaged before connection. The PhoCheck Tiger instruments ingress protection rating is reduced to IP20 when its battery pack is removed so avoid changing batteries in dusty or wet environments.
<b>BATTERY USE:</b>	Use supplied battery packs only on the PhoCheck Tiger. Never replace primary alkaline battery cells while in a potentially explosive or hazardous location. Use only Industrial by Duracell ID1500 batteries.
<b>FUNCTIONAL TEST:</b>	The PhoCheck Tiger must be functionally checked prior to entering a hazardous area after every occasion when a connection has been made to the USB port. The instrument must complete its start-up routine and display legible readings. If the LCD display fails to show an intelligible and uncorrupted display the instrument must not enter a hazardous area.
<b>USB CONNECTION:</b>	The USB port can only be used in a Non Hazardous environment.
<b>PROBE USE:</b>	When using the Probe part numbers A-861414, A-861413 the Safety rating of the Phocheck Tiger Instrument drops from II 1 G Ex ia IIC T4 Ga to II 1 G Ex ia <a href="#">IIB</a> T4 Ga. The temperature performance of the unit is unaffected.
<b>Proper Use:</b>	If the equipment is used in a manner not specified by the manufacturer, the protection provided by the equipment may be impaired.
<b>Type of safety protection:</b>	Intrinsically safe.

## Avertissement

<b>MODE D'EMPLOI:</b>	Veillez lire entièrement et comprendre ce mode d'emploi avant d'utiliser l'instrument PhoCheck Tiger.
<b>RISQUES LIÉS AUX PROPRIÉTÉS ANTISTATIQUES:</b>	N'utilisez pas de détergents abrasifs ou chimiques pour nettoyer l'instrument PhoCheck Tiger, au risque de réduire les propriétés antistatiques des matériaux utilisés. Employez uniquement un chiffon humide.
<b>EXPOSITION AUX MATÉRIAUX:</b>	N'exposez pas le PhoCheck Tiger à des atmosphères connues pour avoir un effet indésirable sur la polyoléfine thermoplastique ou le PC/l'ABS antistatique.
<b>ENTRETIEN:</b>	<p>Ne retirez pas le couvercle du capteur dans les zones dangereuses.</p> <p>N'ouvrez aucune partie du PhoCheck Tiger dans une zone dangereuse, sauf pour le remplacement de la batterie. L'entretien du PhoCheck Tiger doit se dérouler dans un environnement non dangereux et être confié uniquement à des centres de service agréés Ion Science.</p> <p>Ne procédez pas à l'entretien de l'instrument lorsqu'il est sous tension. Otez la batterie avant l'entretien.</p> <p>Le remplacement de composants risque de nuire à la sécurité intrinsèque.</p>
<b>CHARGE DE LA BATTERIE:</b>	Chargez le PhoCheck Tiger et sa batterie lithium-ion uniquement dans un environnement non dangereux.
<b>REMPLACEMENT DES PILES:</b>	Ne remplacez jamais de piles alcalines dans un endroit dangereux ou potentiellement explosif. N'utilisez que des piles alcalines Industrial by Duracell ID1500.
<b>CONNEXION DES PILES/DE LA BATTERIE:</b>	Les batteries lithium-ion et les piles alcalines du PhoCheck Tiger ont été spécialement conçues pour permettre la connexion à l'instrument PhoCheck Tiger dans des atmosphères potentiellement dangereuses. Assurez-vous que les connexions électriques sont propres et intactes avant la connexion. L'indice de protection des instruments PhoCheck Tiger étant ramené à IP 20 lors du retrait de la batterie, évitez de remplacer les batteries dans des environnements poussiéreux ou humides.
<b>UTILISATION DES PILES/DE LA BATTERIE:</b>	<p>N'utilisez que les batteries fournies avec le PhoCheck Tiger.</p> <p>Ne remplacez jamais des piles alcalines primaires dans un endroit dangereux ou potentiellement explosif. N'utilisez que des piles alcalines Industrial by Duracell ID1500.</p>
<b>ESSAI DE FONCTIONNEMENT:</b>	Le PhoCheck Tiger doit subir un essai de fonctionnement avant de pénétrer dans une zone dangereuse chaque fois qu'une connexion a été effectuée au port USB. L'instrument doit terminer sa routine de démarrage et afficher des valeurs lisibles. Si l'écran LCD n'affiche pas de données correctes et intelligibles, n'utilisez pas l'instrument dans une zone dangereuse.
<b>CONNEXION USB:</b>	Le port USB peut uniquement être utilisé dans un environnement non dangereux.
<b>UTILISATION DE LA SONDE:</b>	Lors de l'utilisation des pièces de la sonde dont les numéros vont de A-861414, A-861413, la côte de sécurité de l'instrument Phocheck Tiger se réduit de II 1 G Ex ia IIC T4 Ga à II 1 G Ex ia <b>IIB</b> T4 Ga. La performance de la température de l'unité n'est pas affectée".
<b>Utilisation appropriée:</b>	Si l'équipement est utilisé d'une manière non spécifiée par le fabricant, la protection fournie par l'équipement peut être altérée.
<b>Type de protection de sûreté:</b>	Sécurité intrinsèque.

## Contents

<b>1. Safety</b> .....	<b>8</b>
Legal Notices Regarding the Safe Operation of Equipment .....	8
Symbols.....	8
Warnings and Cautions and Information notifications .....	8
Disposal.....	9
<b>2. Product Overview</b> .....	<b>10</b>
Tiger <sup>LT</sup> PC Software .....	11
TIGER <sup>LT</sup> Kit.....	11
Keypad Function Descriptions .....	12
<b>3. Getting Started</b> .....	<b>13</b>
Fitting the Inlet Probe.....	13
Switching your TIGER <sup>LT</sup> On.....	13
Switching your TIGER <sup>LT</sup> Off .....	13
Checking the Battery Charge.....	14
Set Alarm Levels.....	14
<b>4. Understanding the Display Screen</b> .....	<b>15</b>
Overview.....	15
Status Icons.....	15
Soft Key Options .....	17
<b>5. Using the TIGER<sup>LT</sup></b> .....	<b>18</b>
Turning On / Off.....	18
Turning On .....	18
Turning Off.....	18
Setup Functions .....	18
<b>6. Using the Tiger<sup>LT</sup> PC Software and Downloading Data</b> .....	<b>21</b>
PC Requirements .....	21
Installation of Tiger <sup>LT</sup> PC Software.....	21
Connecting a TIGER <sup>LT</sup> to a PC.....	21
Opening Tiger <sup>LT</sup> PC.....	22
Help Screen .....	23

The Instruments List .....	23
Downloading Data Logged Readings and Instrument Settings .....	24
Taking Snapshots .....	25
Instrument Summary Screen .....	26
Configuration Screen .....	27
Firmware Screen .....	31
Datalog Screen .....	34
Snapshots Screen .....	36
<b>7. Calibration .....</b>	<b>39</b>
Calibration .....	39
Custom Calibration .....	39
Maintenance.....	41
TIGER <sup>LT</sup> Parts Diagram .....	42
Batteries.....	42
Battery Packs .....	42
Recharging Batteries.....	43
Replacement of Rechargeable Battery Packs.....	44
Replacement of Non-rechargeable Batteries.....	45
Inlet Probe Assembly .....	46
PTFE Filter Disc.....	46
Probe Seal .....	46
Water Ingress.....	47
Lamp Cleaning and Electrode Stack Replacement .....	47
When to Clean or Replace the Lamp .....	47
When to Replace the Electrode Stack .....	47
Removing the MiniPID 2 Sensor .....	47
Lamp Removal and Examination .....	48
Lamp Cleaning.....	49
Replacing a Lamp .....	50
Replacing the MiniPID Electrode Stack.....	50
<b>8. Troubleshooting.....</b>	<b>52</b>

Diagnostics.....52

**9. Appendix and Supporting Documents ..... 53**

EU Declaration of Conformity.....53

Technical Specifications.....54

Warranty.....55

ION Science Contact Details .....56

    UK and Head Office.....56

    USA Office .....56

    German Office.....56

    Italian Office.....56

    French Office.....56

    Chinese Office .....56

    Indian Office.....56

Manual Log .....57

## 1. Safety

### Legal Notices Regarding the Safe Operation of Equipment

- Whilst every attempt is made to ensure the accuracy of the information contained in this manual, ION Science accepts no liability for errors or omissions in the manual, or any consequences deriving from the use of information contained herein. It is provided “as is” and without any representation, term, condition or warranty of any kind, either expressed or implied.
- To the extent permitted by law, ION Science shall not be liable to any person or entity for any loss or damage which may arise from the use of this manual.
- We reserve the right at any time and without any notice to remove, amend or vary any of the content which appears in this manual.

### Symbols



**WARNING!**  
USED TO INDICATE DANGER WARNINGS WHERE THERE IS A RISK OF INJURY OR DEATH.



**Caution**  
Used to indicate a caution where there is a risk of damage to equipment.



**Information**  
Important information or useful hints about usage.



**Recycling**  
Recycle all packaging.



**WEEE Regulations**  
Ensure that waste electrical equipment is disposed of correctly.

### Warnings and Cautions and Information notifications

The following apply to the product described in this manual.



**BATTERY CHARGING: CHARGE THE TIGER AND ITS LITHIUM BATTERY PACKS IN A NON HAZARDOUS ENVIRONMENT ONLY.**



**The instrument should be used in accordance with the safety standards and installation instructions given in this manual, and in compliance with local safety standards.**





**Responsibility for use:** TIGER<sup>LT</sup> instruments detect a large range of gases which are potentially dangerous from both a poisoning and/or an explosive perspective. TIGER<sup>LT</sup> instruments have many adjustable and selectable features allowing the instrument to be used in a variety of ways. ION Science Ltd can accept no responsibility for the incorrect adjustment of features that cause harm or damage to persons or property. TIGER<sup>LT</sup> can be used as a personal safety device. It is the user's responsibility to respond appropriately to an alarm situation.



The TIGER<sup>LT</sup> must not be exposed to atmospheres known to have an adverse effect on Thermoplastic polyolefin or Anti-static PC/ABS.



The instrument must be serviced in a Non-Hazardous environment and by ION Science Ltd authorised service centres only. Substitution of components may impair intrinsic safety.



Do not service the instrument live; Remove the Battery Pack before servicing.



**Ingress Protection:** Continuous exposure to wet weather conditions should be limited to less than one day and harsh water spray conditions should be avoided.



When using the Probe part numbers A-861414, A-861413 the Safety rating of the TIGER Instrument drops from II 1 G Ex ia IIC T4 Ga to II 1 G Ex ia IIB T4 Ga. The temperature performance of the unit is unaffected.

### Disposal

- The equipment does not include any toxic materials, but if it has been contaminated by toxic materials, then exercise due care and follow the appropriate regulations when disposing.
- Always adhere to local regulations and procedures when disposing of the equipment.



**RECYCLING**  
Recycle all Packing.



**WEEE REGULATIONS**  
Ensure that all waste electrical equipment is disposed of correctly.





ION Science Ltd offer a take back service. Please contact us for more information.

## 2. Product Overview

The TIGER<sup>LT</sup> is a portable gas detector that uses photo-ionization technology to detect a large range of Volatile Organic Compounds (VOCs) which can be dangerous from both a poisoning and explosive perspective.

The TIGER uses a Photo-Ionization Detector (PID) to measure gas concentrations. The patented fence electrode technology minimises the effects of moisture and contamination, avoiding the need for compensation.

The TIGER has an intuitive graphical interface allowing easy access to instrument settings. Two keys **A**  and **B**  can be configured to suit the user's application, so many functions can be selected without entering the main menu structure. This improves efficiency of use, particularly with repeatable tasks.



The TIGER has been designed and certified Intrinsically Safe.



- |   |                    |   |                 |
|---|--------------------|---|-----------------|
| 1 | Charge Cradle      | 5 | Display Screen  |
| 2 | Instrument Boot    | 6 | Keypad          |
| 3 | Alarm LEDs / Torch | 7 | Instrument Body |
| 4 | Probe Assembly     | 8 | Battery Pack    |



**9** Charging Contacts

**10** Sensor Cover

**11** Pump Outlet

**12** USB Port (Type B)

### Tiger<sup>LT</sup>PC Software

The Tiger<sup>LT</sup>PC software enables you to fully configure the instrument.

We recommend you install the software and set up your TIGER<sup>LT</sup> as described in [Tiger LT PC Software](#).

### TIGER<sup>LT</sup> Kit











ION Science provides a range of TIGER kits and accessories. The content of a standard kit is:

- TIGER<sup>LT</sup> instrument
- Rechargeable Battery (Li-ion) - one per kit
- Battery Charge Cradle and Mains Adaptor
- Instrument Boot
- TIGER<sup>LT</sup> Manual - free download from website
- TIGER<sup>LT</sup> Quick Start Guide
- PTFE Filter Discs
- Removal Tool for MiniPID Stack
- Sample Cleaning Compound

- USB Cable
- Cleaning buds
- Lightweight carry case

For details of different kits and other accessories, contact [ION Science](http://ION Science) or your local distributor.

### Keypad Function Descriptions

	<p>The functionality of the <b>A</b> and <b>B</b> keys varies. Prompts on the display indicate their functionality at a given time.</p>	
		
	<p>The <b>Up</b> and <b>Down</b> keys are used to adjust settings and navigate through the menu structure.</p>	
		
	<p>The <b>Esc</b> (Escape) key is used to cancel a change or exit a menu.</p>	
	<p>The <b>Enter / On / Off</b> key is used to accept changes, select functions, and to turn the TIGER on and off.</p>	

In general, setup and application settings are selected and adjusted using the soft keys. Options are selected using the arrow keys and confirmed using the **Enter** key or a soft key.

A continuous press is used to scroll through options and numbers, e.g. to change the gas selection by scrolling through the available selections until the required gas selection is displayed.

### 3. Getting Started

#### Fitting the Inlet Probe

Ensure that the inlet probe supplied is fitted to your TIGER<sup>LT</sup>.

#### Switching your TIGER<sup>LT</sup> On

Press the **Enter / On / Off** key once to turn TIGER<sup>LT</sup> On. 

The lights will flash white, red, then amber, and a “beep” will sound. You should also be able to hear the pump start operating.

The display will initially display the ION Science logo and the firmware version installed on it.

The display will then show the instrument checking that the Lamp is working (the  symbol is displayed).

Next, [if the instrument is set to Zero when switched on](#), the screen will display the  symbol.

The main running screen is then displayed:



Your instrument is now ready to use.

#### Switching your TIGER<sup>LT</sup> Off

Press and hold the **Enter / On / Off** key for 3 seconds to turn TIGER<sup>LT</sup> Off. A 3-second countdown will be displayed on the screen. While this is happening, a continuous beep will sound, and the lights will flash red.

Once the instrument is switched off, wait a few seconds before switching on again.

### Checking the Battery Charge

Check that your TIGER<sup>LT</sup> has sufficient charge for use. The battery icon should show at least two full segments. If not, the instrument should be charged to at least this level before use.



TIGER<sup>LT</sup> instruments leave the factory with their Rechargeable Battery Pack fully charged. However, prolonged periods of storage may result in the Rechargeable Battery Pack discharging. We recommend charging the instrument for seven hours before first use.

A non-rechargeable AA Battery Pack can also be used, but it is recommended that it only be used if no power is available to recharge the Rechargeable Battery Pack.

### Set Alarm Levels

We recommend that alarm levels are set to user specifications as soon as possible before the TIGER<sup>LT</sup> is first used. See [Alarms](#) for details.

## 4. Understanding the Display Screen



**IF AN ALARM STATE IS TRIGGERED THE USER SHOULD LEAVE THE HAZARDOUS ENVIRONMENT AND ACT IN ACCORDANCE WITH NATIONAL SAFETY REGULATIONS.**

### Overview



The main central viewing screen will display readings in large numbers only, 4 digits and decimal place will display 0.0 ppm to 5,000 ppm. When the maximum range is exceeded and the sensor over-ranges, the display will show '9999'. Two soft key areas have been set aside as soft key indicators. The area between the soft key indicators displays the measurement units.

### Status Icons



**Memory Status:** Four sections within the border fill as the data log memory is filled. Empty border = 100% memory available through to full, where all segments are present. The icon fills as data log memory is filled. It will flash when multi-logging is activated.



**USB:** This is displayed when the instrument is connected to a PC.

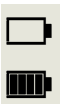

**Battery Status:** A standard [battery charge](#) indicator. When the battery is nearly discharged, the final segment flashes for one minute before the instrument shuts down.



**Backlight:** Light beam lines appear when the backlight is on.



**Sound:** The top icon is displayed if all three alarm sounders are off and the volume is set to 0%.



Otherwise, zero to three sound projection lines are displayed to indicate the volume level (there are four sound levels; no line is displayed for the quietest).



**Alarm Bell:** When a 'Low alarm' is triggered, the bell symbol and one curved line on either side of the bell symbol will flash.

When a 'High alarm' is triggered the bell symbol and two curved lines on either side of the bell symbol will flash.



**Flashlight / Torch:** This is displayed when the flashlight/torch is turned on by pressing the **A** and **B** keys simultaneously.



**Lock:** The lock icon is displayed when the configuration of the TIGER has been locked in Tiger<sup>LT</sup>PC.

Options associated with soft key **A** are enabled.

Options associated with soft key **B** are disabled.



### Soft Key Options

The following icons are displayed in the soft key areas as soft key options. They are selected using the **Up** and **Down** keys.

These icons can be reorganised or hidden using the Tiger PC software. Refer to the [Configuration](#) section of Tiger<sup>LT</sup>PC for details.

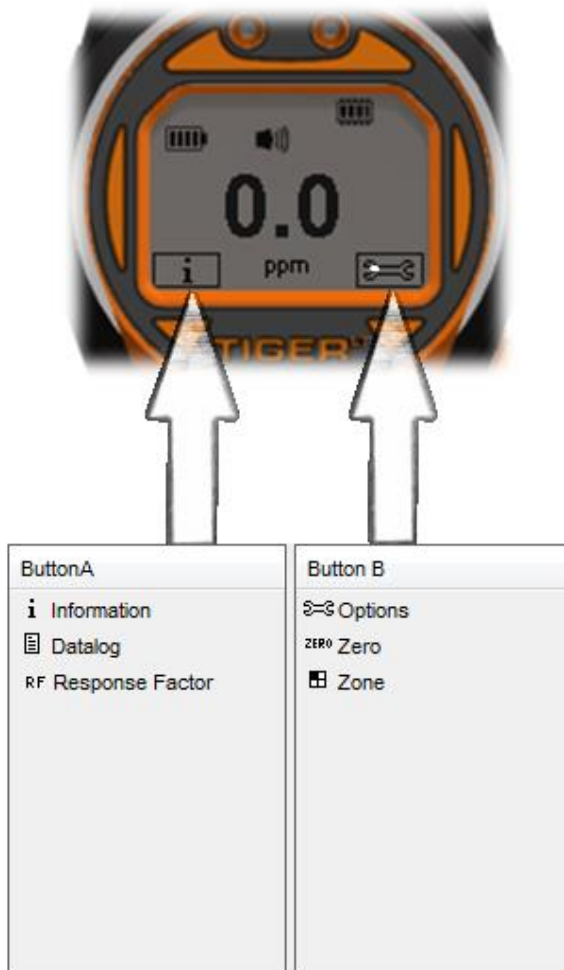

## 5. Using the TIGER<sup>LT</sup>

Instrument functionality is split into two parts; Application and Setup. Application settings are initially selected via the keys **A** and **B**. Setup functions like Backlight, Sound, Calibration and Alarm Setting are adjusted within **Options**. Many of the screens have a 2 second time-out which returns to the main screen if no other keys are pressed.

### Turning On / Off

#### Turning On

To switch the TIGER<sup>LT</sup> on press the **Enter / On / Off** key once. The device will display logo and info screens during the start-up sequence.

The device will then zero before displaying the main running screen. We encourage users to leave the device running for 10 to 15 minutes prior to use. The TIGER<sup>LT</sup> is now ready to use.



#### Turning Off

To switch the TIGER<sup>LT</sup> off press and hold the Enter/ On / Off key. A three second count down takes place before the instrument shuts down. During this count down the instrument activates the upper alarm, visual red LED's flash and audible alarm sounds. This is done to alert the user to avoid accidental switch off.

### Setup Functions

#### Calibration

When selected, the user is presented with two options:

-  **Factory**: You can set your instrument to operate using the factory calibrated values. These are set by ION Science Ltd or authorised service centres.
-  **Custom** Custom calibration should be carried out as part of regular instrument maintenance.

Refer to [Calibration](#) for details of calibration procedures.

#### Options

The **Options** soft key accesses several instrument settings. These include:

- **Backlight**   
Refer to the [Tiger<sup>LT</sup>PC Configuration Screen](#) topic for details of these options. Select the preferred option with the **Up** and **Down** keys and confirm with **Enter**. Note that if the limited time option is selected, the time is set using Tiger<sup>LT</sup>PC.

- **Sound**

Refer to the [Tiger<sup>LT</sup>PC Configuration Screen](#) topic for details of these options. Select the preferred option with the **Up** and **Down** keys and confirm with **Enter**.

For percentage volume, press **Enter** again to confirm selection. The frame will flash. Use the **Up** and **Down** keys to change the percentage volume and press **Enter** to confirm the chosen value.

- **Alarms**

Upper and lower alarms levels for the selected gas are taken from gas tables. They can be [changed using Tiger<sup>LT</sup>PC](#), or via this option.

Upper and lower alarm options are displayed. Select an alarm using the **Up** and **Down** keys and press **Enter**. The arrow(s) on the chosen alarm will flash. Adjust the level using the **Up** and **Down** keys and press **Enter**. Repeat if necessary for the other alarm.



The lower alarm setting should never be greater than the upper alarm. Therefore, if the lower alarm is set to higher than the upper alarm, the upper alarm is automatically incremented to the lower alarm level plus 1.

**Zeroing**

Pressing the **Zero** soft key presents two Zero options . Use the **Up** or **Down** keys to select them. The upper symbol represents an absolute Zero. The lower symbol represents a relative Zero, which follows the drift of the MiniPID 2 Sensor.











The screen displays a tick '✓' to confirm your selection. If the relative Zero has been selected, TIGER<sup>LT</sup> will then Zero itself.

**Information**

Pressing the **Information** soft key provides access to a list of screens which display the current settings of the TIGER<sup>LT</sup>. Use the **Up** and **Down** keys to scroll through the list and press **Enter** to view a screen. Press **Esc** to return to the main running screen.

<b>First screen</b>	Response Factor	
	Upper alarm	
	Lower alarm	

<b>Second screen</b>	Date of Factory Calibration	
----------------------	-----------------------------	--

	Date of Custom Calibration	
<b>Third screen</b>	SPAN 1	
	PID output (ppm)	
	MiniPID 2 Sensor PID Sensor A/D reading	
<b>Fourth screen</b>	Internal Reference Number	
	Firmware version	
	Bootloader version	
	Battery type and voltage	
<b>Fifth screen</b>	Memory available % free	
	Date and time	

**Zones** 

Press the **Zone** soft key to display the name of the currently selected Zone:  ROOM 2. The TIGER default is '001'. [Zones are set up in Tiger<sup>LT</sup> PC](#). Use the **Up** and **Down** keys to select other zones.

**Data Logging: Single-log (push-to-log)** 

Press the **Single Data Log** soft key to take a single data log reading. The Single Data Log symbol appears briefly with a tick  before returning to the main screen. Press **Esc** to return to the main screen. Press the **Single Data Log** soft key again to take another reading. The [memory status icon](#) flashes when a single data log reading is taken.

**Sleep Mode** 

The instrument can enter Sleep Mode [automatically when connected to a PC](#). This is a power saving function.

## 6. Using the Tiger<sup>LT</sup> PC Software and Downloading Data

The Tiger<sup>LT</sup> PC software enables you to fully configure the instrument.

### PC Requirements

Tiger<sup>LT</sup> PC Software must be used in conjunction with a PC or laptop using Windows 10.

### Installation of Tiger<sup>LT</sup> PC Software

Download the Tiger<sup>LT</sup> PC software from the ION Science website:

[www.ionscience.com](http://www.ionscience.com)

Run setup.exe to install the software.

Alternatively, the Tiger<sup>LT</sup> PC software can be purchased on a memory stick.

Follow the prompts until the installation is complete. Should you have difficulty, please contact your local distributor, or contact ION Science directly:

[www.ionscience.com](http://www.ionscience.com)

### Connecting a TIGER<sup>LT</sup> to a PC



**The TIGER<sup>LT</sup> must be functionally checked prior to entering a hazardous area after every occasion when a connection has been made to the USB port. The instrument must complete its start-up routine and display legible readings. If the LCD display fails to show an intelligible and uncorrupted display the instrument must not enter a hazardous area.**

Connect your TIGER<sup>LT</sup> to the PC. The (type B) USB port of the TIGER<sup>LT</sup> is located at the back of the instrument, above the charging connectors. A flap on the Instrument Boot can be opened to reveal it.

While the TIGER<sup>LT</sup> is connected, the instrument will go into Sleep Mode [if set to do so in Tiger<sup>LT</sup>PC](#). The instrument will “awaken” when it is disconnected.

## Opening Tiger<sup>LT</sup>PC

Before opening Tiger<sup>LT</sup>PC, connect your TIGER<sup>LT</sup> to the PC.

Double-click the Tiger<sup>LT</sup> icon on your desktop or in the Start menu to open Tiger<sup>LT</sup>PC (or run Tiger.exe in the installation folder). The Home page will be displayed:



## Help Screen

This screen will inform you if a new version of PC software is available. You can then install the upgrade if required. We recommend that Tiger<sup>LT</sup>PC is kept up to date to ensure that the latest functionality is available to you.

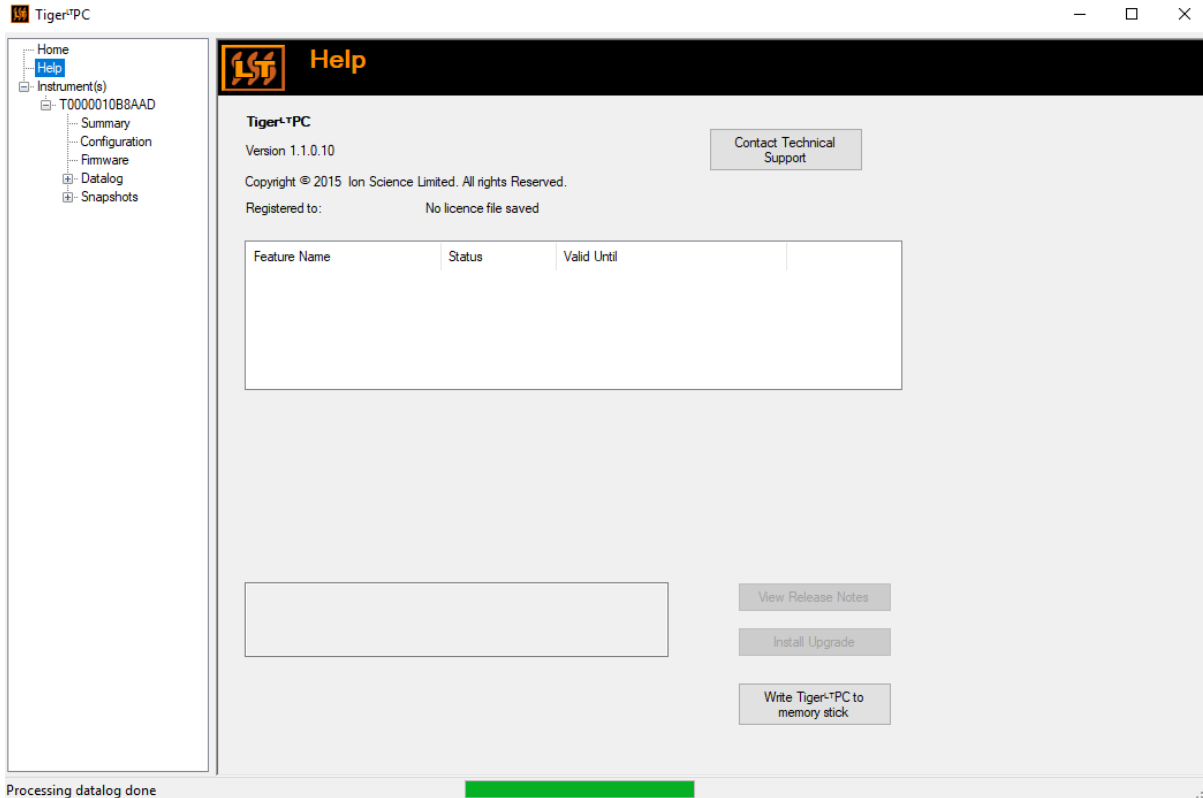

To install an upgrade, press **Install Upgrade**. The following are then displayed:

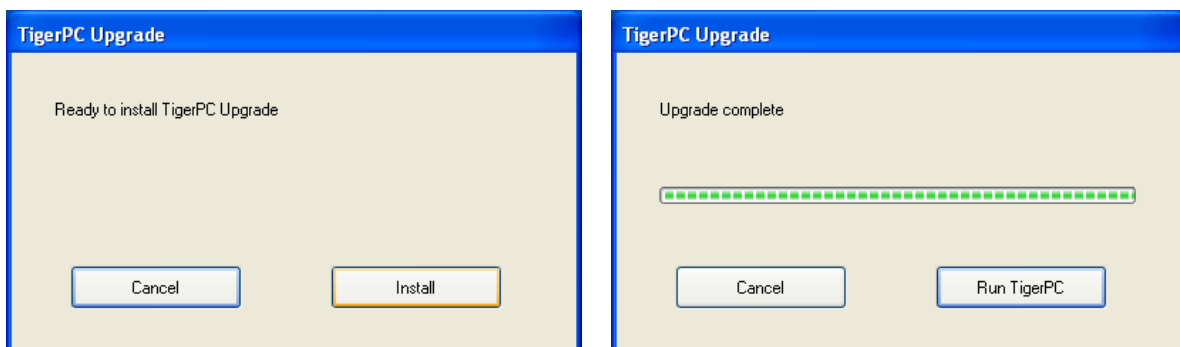

## The Instruments List

The **Instrument(s)** list in the menu lists the Internal Reference Numbers (IRNs) of the TIGER<sup>LT</sup> instruments that Tiger<sup>LT</sup>PC has previously interfaced with and listed. Your instrument will be added to this list once Tiger<sup>LT</sup>PC has “read” it, as described next.

### Downloading Data Logged Readings and Instrument Settings

Click **Instrument(s)**. The page that is then displayed lists the instruments that Tiger<sup>LT</sup>PC has previously listed.

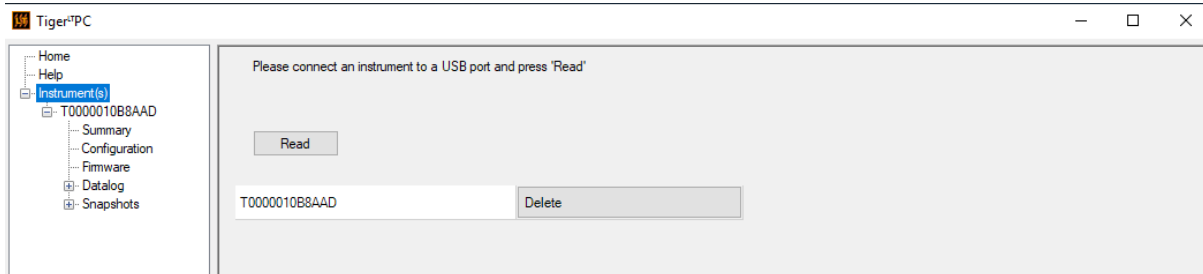

To download data from the connected instrument (and to add it to the instrument list if it hasn't been listed with Tiger<sup>LT</sup>PC before) click **Read**.

The current setup of the instrument and logged data is then downloaded:

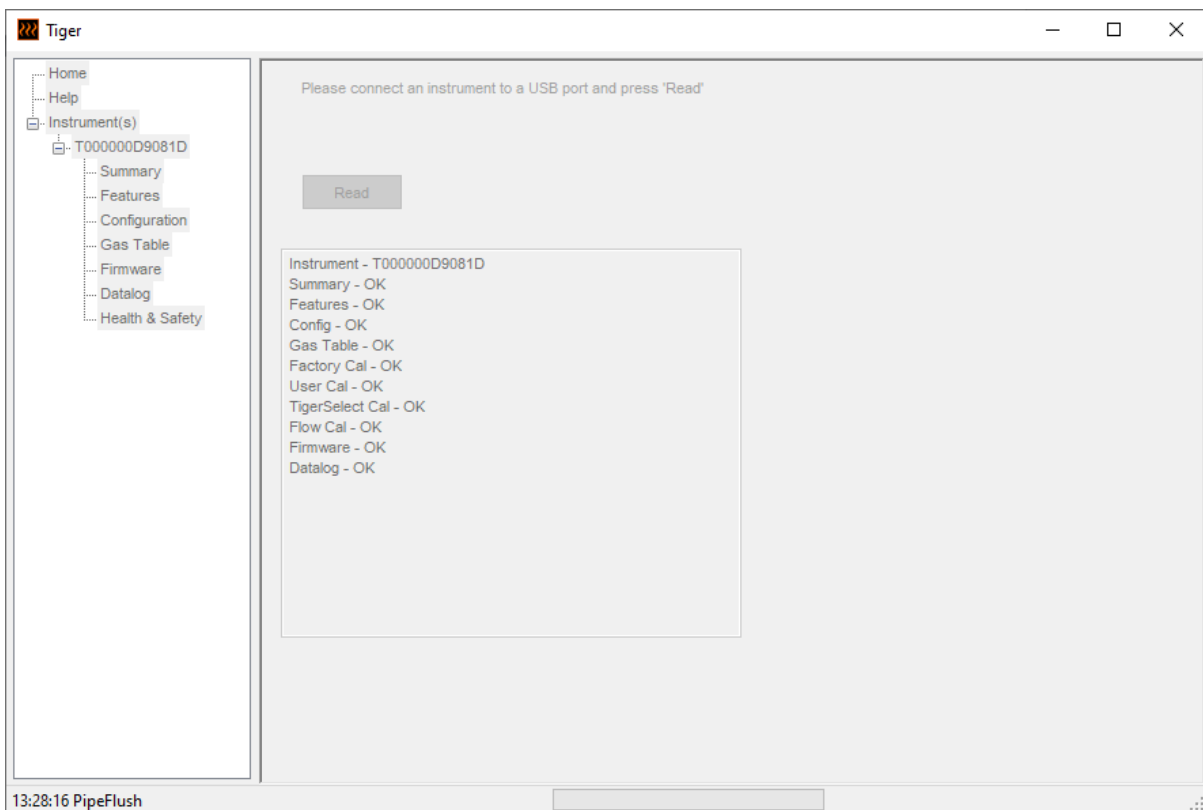

To remove an instrument from the list, click **Delete**. All details of the instrument are then removed from the software. If that instrument is connected again, it will be treated as a new (previously unlisted) instrument by Tiger<sup>LT</sup>PC.

If not already listed, the instrument IRN will be added to the list of instruments.



## Taking Snapshots

The first time you “read” an instrument a snapshot is taken automatically (see [Snapshots Screen](#)). On subsequent occasions this pop-up is displayed:

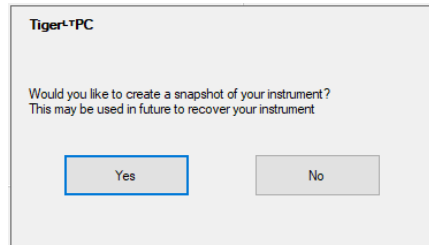

Click **Yes** or **No** as required.

To take a snapshot of a connected instrument at any time, click on the IRN of the instrument in the **Instrument(s)** list, then click **Take Snapshot** on the screen that is then displayed.

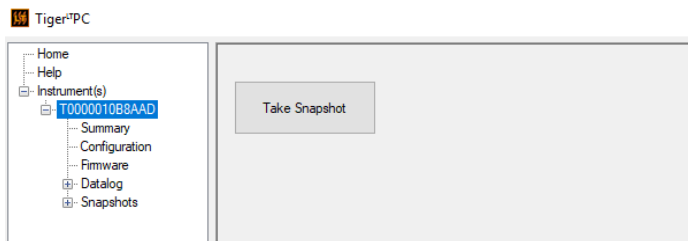

### Instrument Summary Screen

Once an instrument has been read, expand its entry in the menu and click on **Summary** to display the [Instrument Summary screen](#). This screen shows the current status and properties of your TIGER<sup>LT</sup>.

**Instrument Summary**  
T0000010B8AAD

IRN	T0000010B8AAD	
Startup Text	Natalie's Tiger LT	
Run Time	34 hours 02 minutes	

Factory Calibration		
Calibration Date	25/07/2114 19:12:08	
Response Factor	1.0	
	Low Gain	High Gain
Zero A/D Reading	308100	308064
102.4 ppm A/D Reading	580337	7671507
5100 ppm A/D Reading	9067782	

Custom Calibration		
Calibration Date	14/07/2017 16:26:36	
Response Factor	1.0	
	Low Gain	High Gain
Zero A/D Reading	308146	308074
102.4 ppm A/D Reading	588630	7894516
1003 ppm A/D Reading	2576655	

Firmware Version: V0.5.12

Datalog Used:

File System Remaining:

Clock: 18/12/2017 12:27:53

## Configuration Screen

Use this screen to configure your TIGER<sup>LT</sup>.

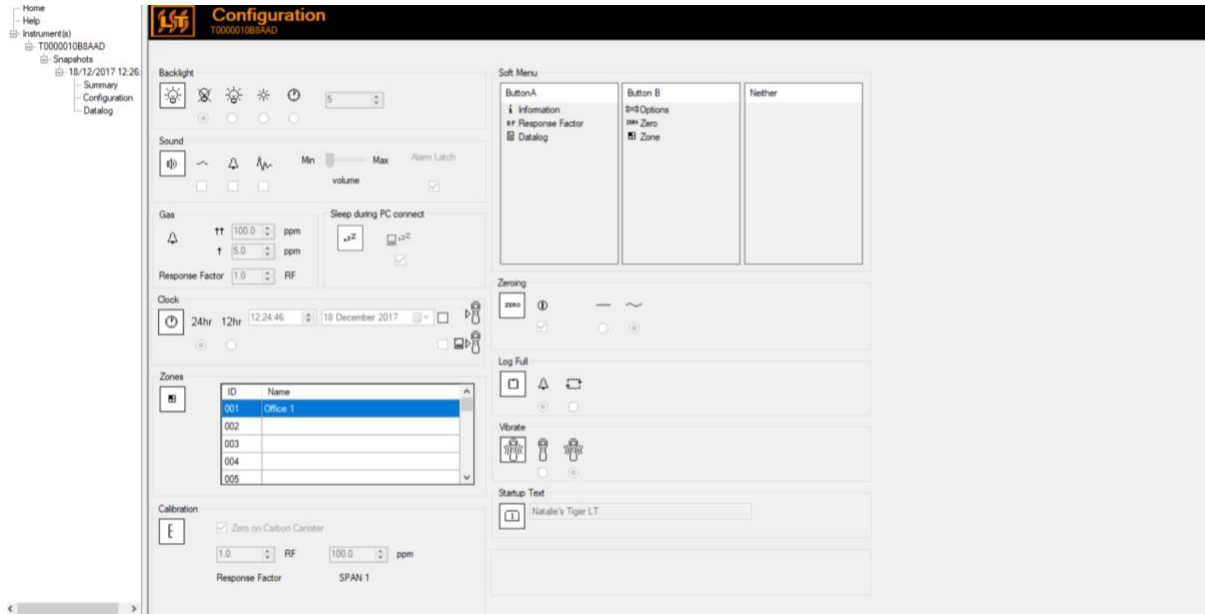

## Backlight

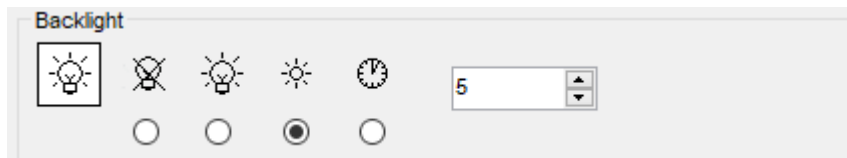

Choose from:

- Permanently off
- Permanently on
- On in low ambient light
- On for limited time

Enter time for the limited time option in the field provided (1 - 99 seconds).

### Sound

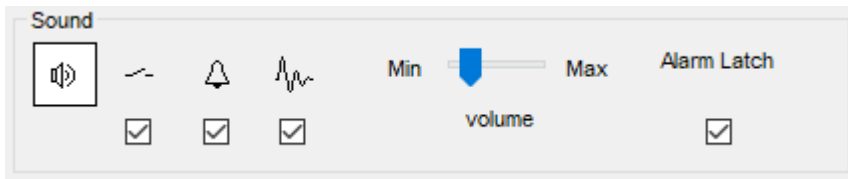

The following options are available:

- Key press sounds
- Audible alarms
- “Crescendo”, i.e. the volume of the low level alarm sound increases as the upper alarm level is approached
- **Alarm Latch:** alarms continue to sound, even if the gas level falls below the threshold, until the **Esc** key is pressed. If **Alarm Latch** is not set, user set alarms conditions are triggered and reset based on the alarm thresholds in the user settings.

Volume is adjusted using the slider.

### Vibrate

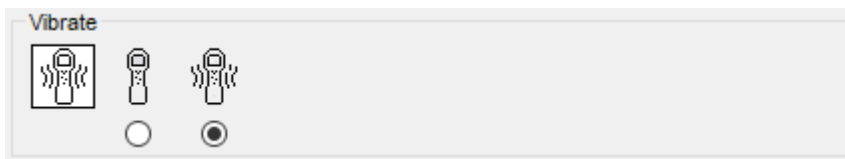

Use to set your TIGER to vibrate under alarm conditions.

### Calibration

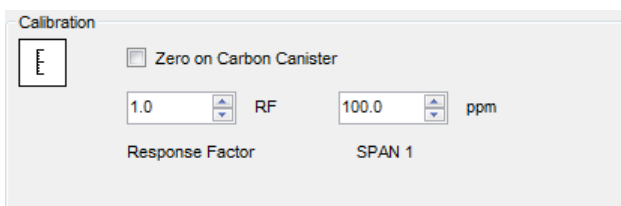



Use this area to define your Custom Calibration parameters.

First connect TIGER<sup>LT</sup> to your PC.

TIGER PC<sup>LT</sup> offers a two-point custom calibration (zero + span). Send this information to your TIGER<sup>LT</sup>.

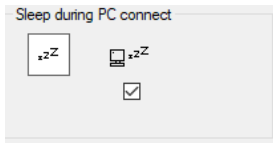
### Sleep during PC connect





-  When connected to a PC the instrument will go into Sleep Mode. The instrument will “awaken” when disconnected from the PC.

### Zeroing



The following options are available:

-  When selected, the TIGER<sup>LT</sup> will automatically set its Zero reading based on ambient air when it is switched on. When deselected the instrument will use its calibration Zero.
-  When selected, TIGER<sup>LT</sup> uses the fixed calibration Zero. If used in conjunction with the ‘Zero at switch on’ option the instrument will Zero at switch on and then remain at that level.
-  When selected, the Zero level will change to negative if cleaner ambient air is detected. This ensures 0.0 ppm is displayed in clean air and ensures sub ppb levels are always detected.

### Zones

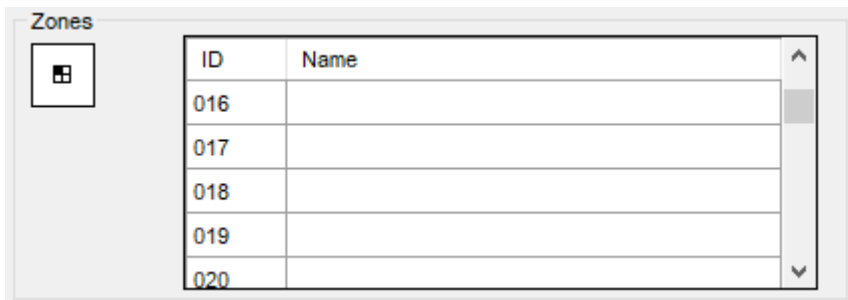

ID	Name
016	
017	
018	
019	
020	

Use this table to define and name up to 128 separate zones. The name field is limited to eight characters including spaces.

### Log Full

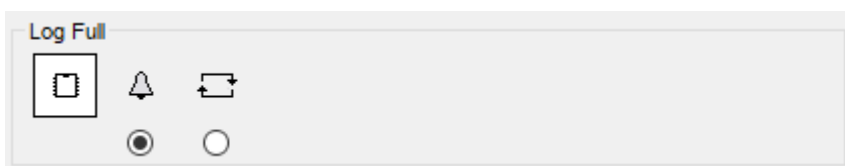

Select one of the following:

- The instrument will alarm when the memory log is full. Logging will stop.
- Logging will continue. New data will overwrite the oldest data in the log.

**Clock**

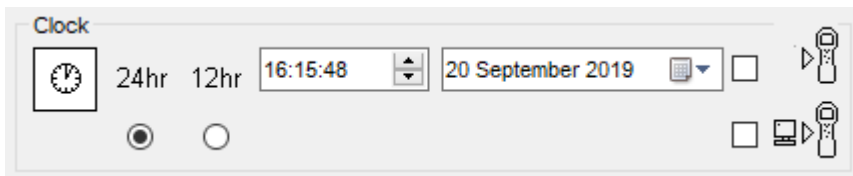

Select 24- or 12-hour format.

If required, select one of the following:

- To set the time on your TIGER<sup>LT</sup>. Set the time and date in the fields provided.
- To synchronise the instruments time with that of the PC.

If neither option is selected, the instrument will use its internal clock.

**Send to Instrument**

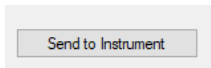

When you have configured your instrument or completed your changes, send them to your TIGER<sup>LT</sup> by clicking **Send to Instrument**.

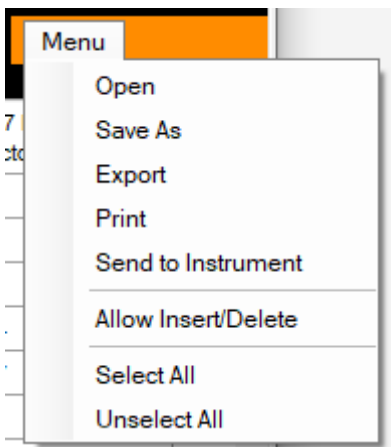

## Firmware Screen

This screen displays the current firmware version installed on your TIGER<sup>LT</sup> and provides facilities to install new versions on the instrument.

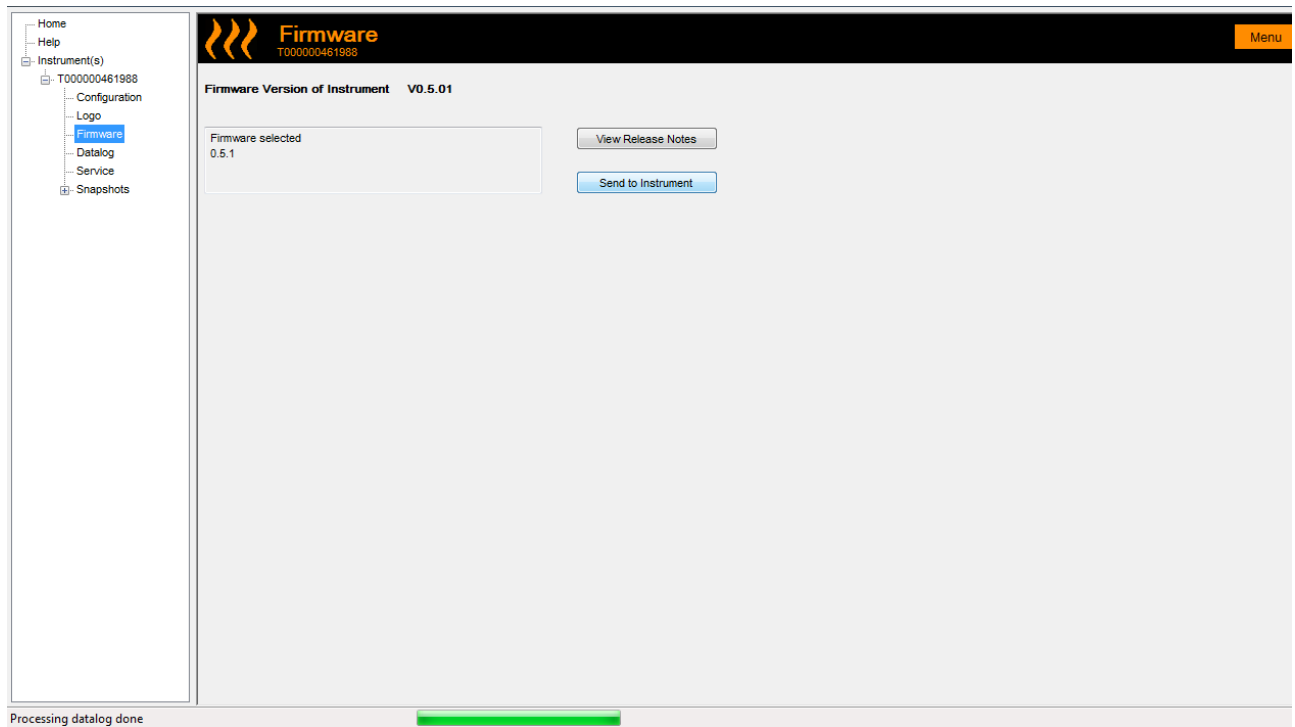

If new firmware is available, this will be noted on the screen in the box under the current firmware version: “New firmware is available”.

Click **View Release Notes** for a description of the changes in the new version.

To install a firmware update, connect TIGER<sup>LT</sup> to your computer as detailed previously. Check that the Battery Pack is sufficiently charged (at least two bars).



**Important:** The Firmware upgrade process will delete all data from the instrument. To avoid loss of any data during the process, [take a snapshot](#) of the instrument before upgrading. This can be reloaded after the update is complete.

Select **Send to Instrument** to install the upgrade on your instrument.

The following message is displayed:

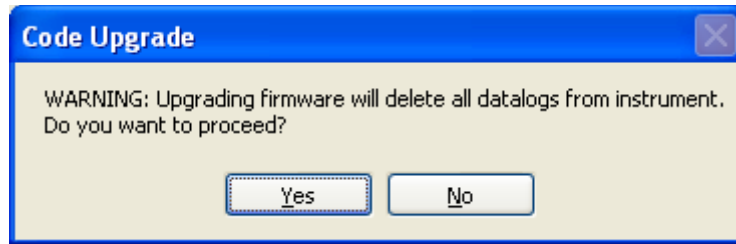

To continue, click **Yes**.

The following message is displayed:

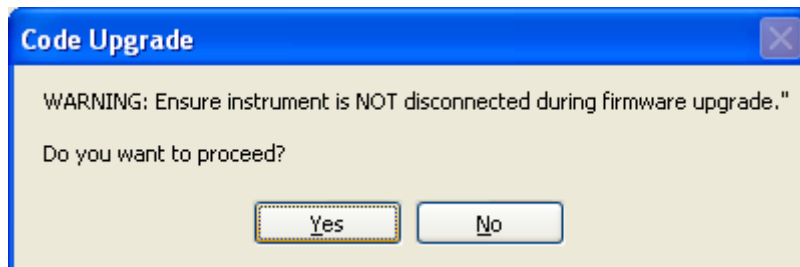

Check that the instrument is connected and click **Yes**.



**Important:** Do not operate your TIGER<sup>LT</sup> during the update process.



The firmware will now be sent to the TIGER<sup>LT</sup>. A bar at the bottom of the screen will indicate the progress of the update.

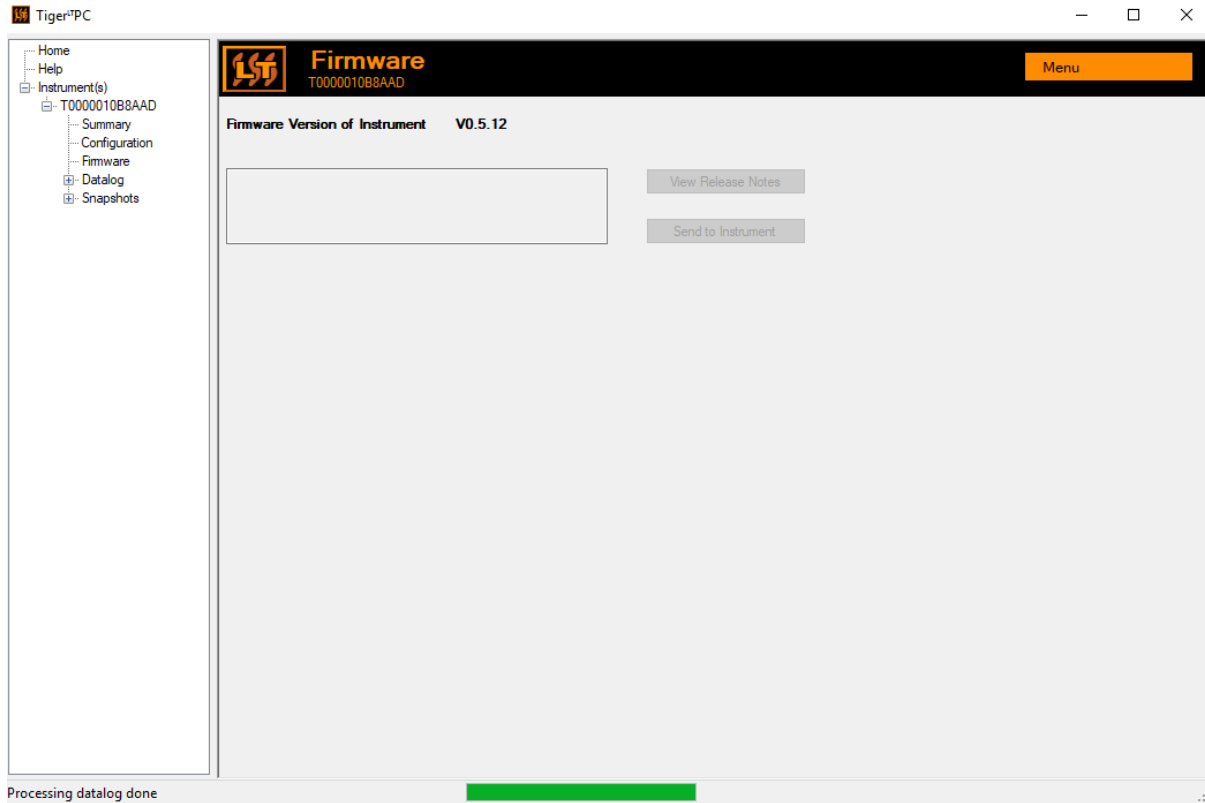

The new firmware version will be shown on the screen.



**Important:** Do not disconnect the TIGER<sup>LT</sup> at this point. Follow the instructions below before disconnecting.

After the upgrade been sent to the TIGER<sup>LT</sup>, the instrument will install it. The TIGER will flash the two torch LEDs. The screen on the TIGER<sup>LT</sup> will remain blank for about 30 seconds. A progress bar will then be displayed as the installation takes place:



A 'verifying file system' message will then be displayed.

The firmware is now installed on the instrument. It will then restart automatically.

### Datalog Screen

This screen is used to view data logged readings downloaded from your TIGER<sup>LT</sup>, if a relevant [upgrade has been installed](#). New readings are downloaded from the TIGER<sup>LT</sup> [when the instrument is read](#).

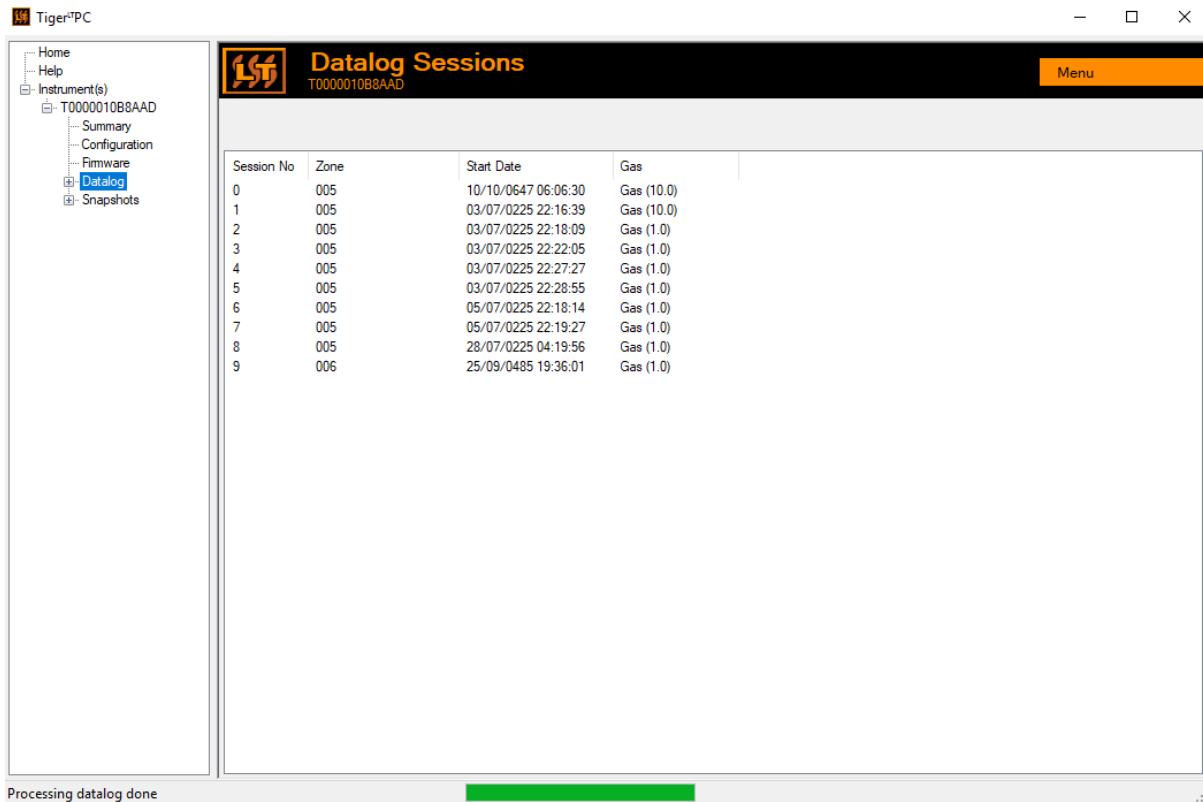

The **Datalog** sub-menu displays a list of the Datalog sessions.

Click on a session. Details of the data collected during that session are presented in numerical and graphical form on the Datalog screen.

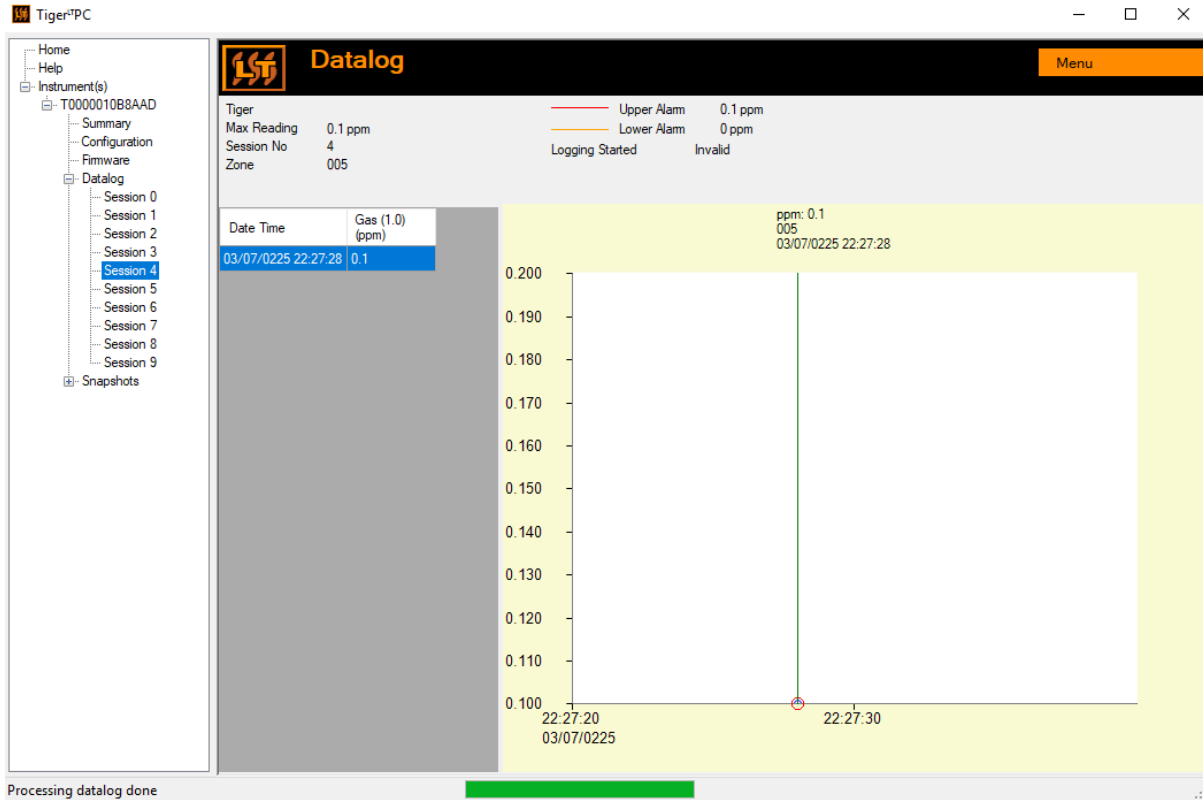

Use the menu accessed from the **Menu** button in the top right-hand corner of the window to zoom, print, or export the data.



**Important:** The **Delete** option on the menu deletes all logged data from your TIGER<sup>LT</sup>. Ensure all valuable data is exported to your PC before selecting it.

## Snapshots Screen

A snapshot records the calibration settings of your TIGER<sup>LT</sup> at a point in time. If required, your TIGER<sup>LT</sup> can be reset to a snapshot's settings. The Snapshots screen lists those stored on the PC.

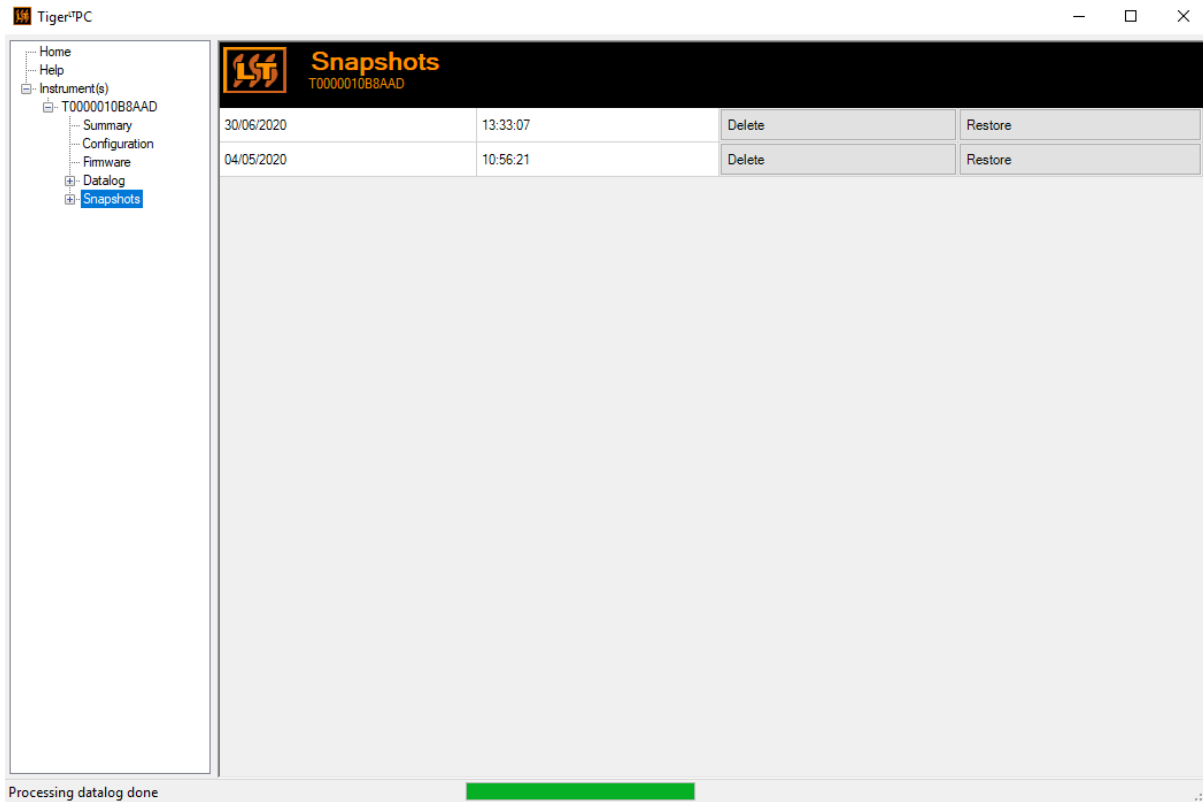

Details of a snapshot can be viewed by expanding the menu entry for that snapshot and accessing

To restore the stored settings to your TIGER<sup>LT</sup>, first ensure that your instrument is fully booted and [connected to your PC as described previously](#). Ensure that your instrument is in normal operation, is not in an alarm condition and that no data logging or Health and Safety readings are being collected.



**Important:** Be aware that this process will replace all setup and calibration files.

Click **Restore** against the relevant snapshot.

On the restore pop-up that is then displayed:

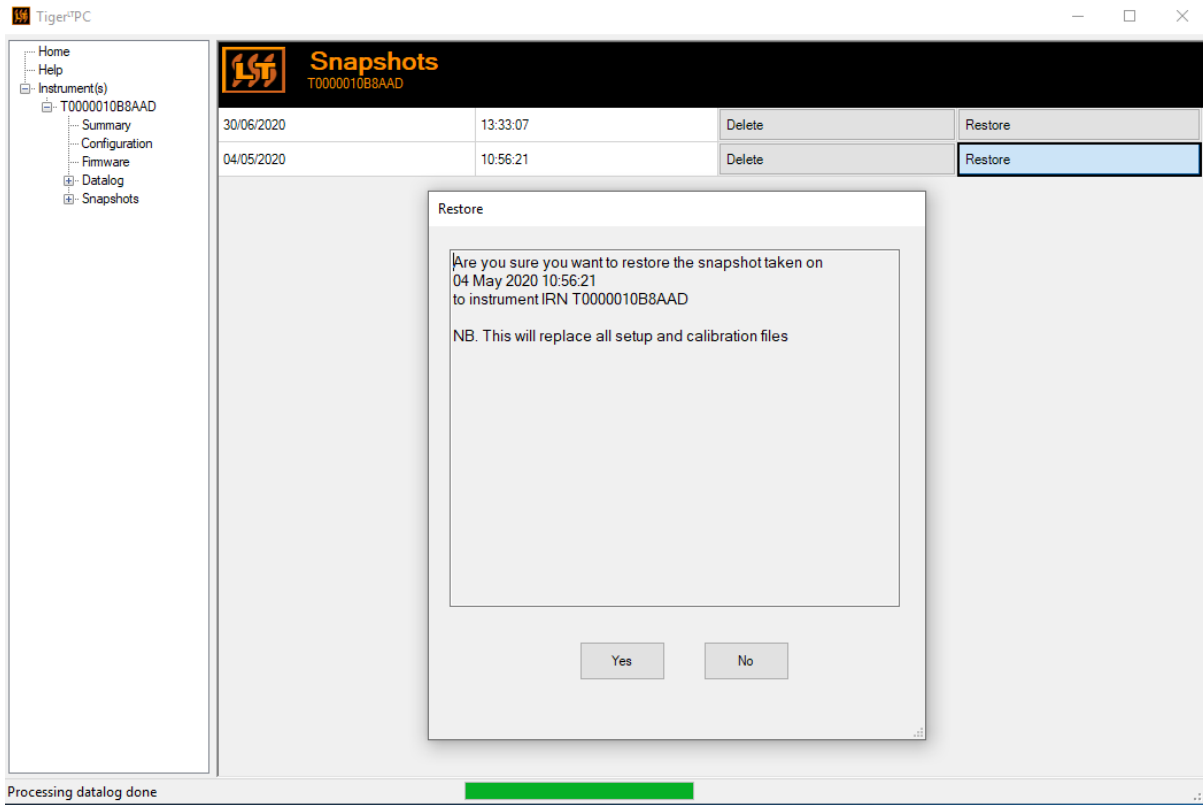

Click **Yes** to load the snapshot. When the loading is complete, click **Close** and restart your TIGER<sup>LT</sup>. Your TIGER<sup>LT</sup> will now be restored to the settings and calibration data stored at the time of that snapshot.

The snapshot menu also allows stored data to be reviewed when an instrument is not attached.

Expand the menu until the relevant snapshot is displayed. Double-click on the snapshot. All the data stored in that snapshot can now be viewed.

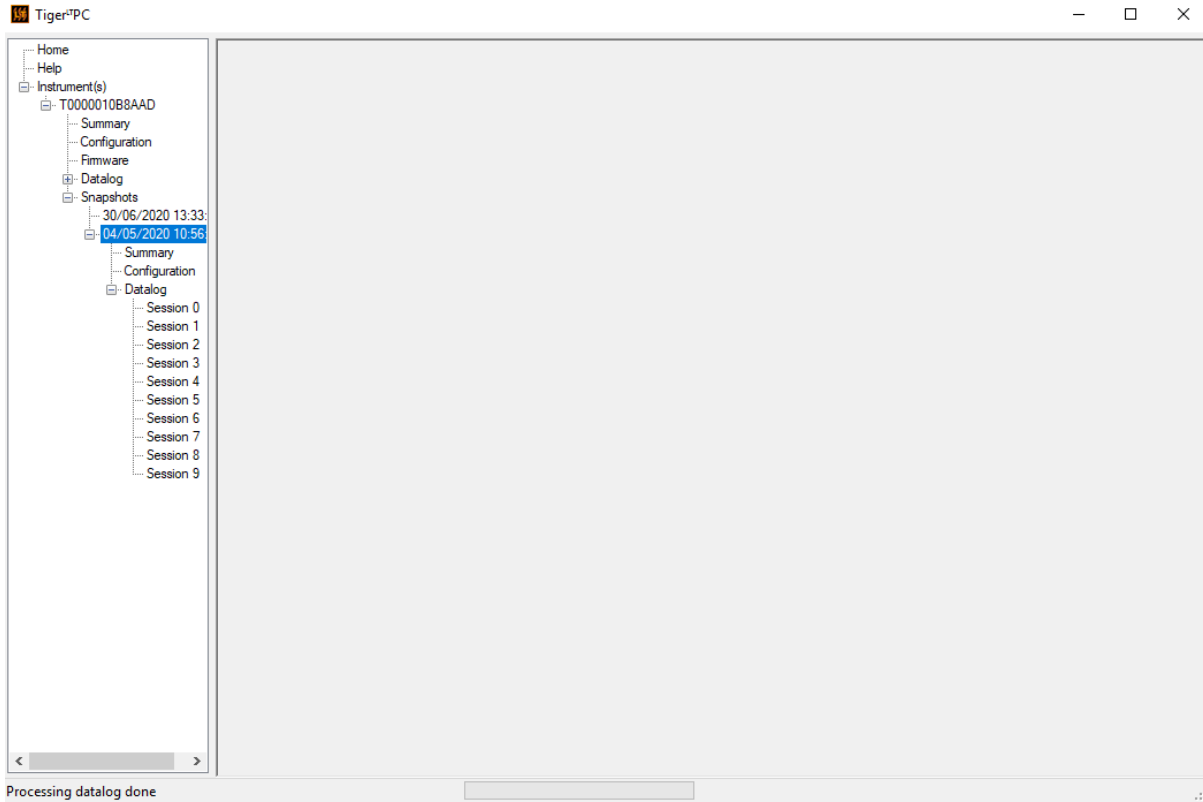

Click **Delete** to remove a selected snapshot.

## 7. Calibration



**ION Science recommends that personnel responsible for equipment use institute a regime of regular checks to ensure it performs within calibration limits, and that a record be maintained which logs calibration check data.**

### Calibration

TIGER<sup>LT</sup> offers the following calibration options:

- Factory Calibration** is set by ION Science Ltd during instrument manufacture or on re-calibration by an ION Science authorised service centre, for example during an annual service. Factory Calibration offers a safe set of three-point calibration data. This should be used if the current custom calibration fails and will keep the unit working until a good custom calibration is completed. Please contact ION Science Ltd or your local distributor for further information.

ION Science Ltd recommends annual servicing and calibrations for users who require traceable calibration records. During this service, the Lamp and MiniPID 2 Sensor are brought back to factory specifications and new Factory Calibration data is loaded.

- Custom Calibration** is performed by the instrument user and should be carried out as part of regular instrument maintenance. Before doing so, first set up the [calibration parameters in Tiger<sup>LT</sup>PC](#).

TIGER<sup>LT</sup> scales its linear output across a Zero level (clean air reference) and the SPAN 1 user-defined gas concentration. Due to the linear output of the ION Science MiniPID 2 Sensor, a two-point calibration is often adequate.

### Custom Calibration

Before proceeding, ensure the [calibration parameters are set in Tiger<sup>LT</sup>PC](#):

Have the cylinder(s) of gas, regulator(s) and a Carbon Filter ready, if using, before starting the procedure. Alternatively, a known clean air supply may be used as the Zero gas. Demand flow regulators are recommended for the calibration of the TIGER<sup>LT</sup>. If flow regulators are to be used then a 0.3l/min is recommended, a flow adaptor should be used to avoid over-pressurising the instrument (sold separately). Please ensure you are familiar with the entire calibration procedure before attempting to calibrate your TIGER<sup>LT</sup>.





The calibration of your TIGER<sup>LT</sup> must be carried out in a clean air environment. Ensure all parts of the Calibration Kit are available and ready for use.



Never calibrate the Zero with the span gas connected.

### Custom Calibration Procedure

From the main running screen, Press the **Options** soft key  on your TIGER<sup>LT</sup> to access the adjustable features.

Then use the **Up** or **Down** key to select calibration.  Press **Enter** to confirm selection.

Select **Custom Calibration**  and press **Enter** to confirm.

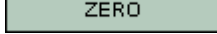
On confirming the selection, the user is presented with a 30 second count down. 

Remove both caps from the Carbon Filter (A-31057) and then fit onto the probe of your TIGER<sup>LT</sup>.



Press **Enter** to start the 'zero' countdown. At the end of the count down a tick '✓' will appear, indicating that the Zero has been accepted. Disconnect the Carbon Filter Assembly and replace the cap ends. The useful life of the Carbon Filter Assembly will be shortened if the Carbon Filter Assembly is open to atmosphere for prolonged periods.

Press **Enter** again and the gas and concentration for Span 1 (previously set up in TIGER PC<sup>LT</sup>) are displayed along with a 30 second countdown.  Attach the 'Span 1' gas using the Calibration Adaptor (861476) (see 'Accessories') and press **Enter** to start the Span 1 countdown. At the end of the count down a tick '✓' will appear, indicating that the Span 1 has been accepted. Press **Enter** and the calibration is complete.



The useful life of the Carbon Filter Assembly will be shortened if it is open to atmosphere for prolonged periods.





## Maintenance



**Inadequate performance of the gas detection equipment described in this manual may not necessarily be self-evident and consequently equipment must be regularly inspected and maintained.**



**Do not use abrasive or chemical detergents to clean the instrument as this may reduce the antistatic properties of the materials used, clean it using a damp cloth only.**

## 8. TIGER<sup>LT</sup> Parts Diagram



- |                              |                        |                      |
|------------------------------|------------------------|----------------------|
| 1. Instrument Body           | 7. Sensor Gasket       | 12. Filter Clamp     |
| 2. Rechargeable Battery Pack | 8. Instrument Boot     | 13. PTFE Filter Disc |
| 3. AA Battery Pack           | 9. Sensor Seal         | 14. Probe - Tiger    |
| 4. Charge Cradle             | 10. Inlet/Outlet Seal  | 15. O-ring           |
| 5. Sensor Cover              | 11. Filter Housing Cap | 16. Probe Seal       |
| 6. MiniPID 2 Sensor          |                        |                      |

### Batteries

#### Battery Packs

Two Battery Packs are available for the TIGER<sup>LT</sup>, a rechargeable Lithium-ion Battery Pack and a non-rechargeable AA Alkaline Battery Pack for 3 AA Alkaline batteries.

- The rechargeable Lithium-ion Battery Pack is recommended for normal operation. The TIGER<sup>LT</sup> is supplied with it as standard.

- The non-rechargeable AA Alkaline Battery Pack should only be used when no power is available to recharge the rechargeable pack.

The Rechargeable Battery Pack is normally fitted as standard to the instrument when shipped.

### Recharging Batteries



**BATTERY CHARGING: CHARGE THE TIGER AND ITS LITHIUM ION BATTERY PACKS IN A NON HAZARDOUS ENVIRONMENT ONLY.**



**Battery Connection: Ensure all electrical connections are clean and undamaged before connection. The TIGER<sup>LT</sup> instrument's ingress protection rating is reduced to IP20 when its Battery Pack is removed so avoid changing batteries in dusty or wet environments.**



**Lithium Ion Batteries can be damaged if left in a discharged state. Please recharge if battery indicator is showing empty. Please note also that if the instrument is left for one year unused, it needs to be charged fully before it can continue to be kept in storage. Please repeat annually.**

Ensure the TIGER<sup>LT</sup> is charged for at least 7 hours before using it for the first time. To ensure optimum charging, the TIGER<sup>LT</sup> should be switched off. If left on, the TIGER<sup>LT</sup> will take longer to charge, but will not suffer any damage. The TIGER<sup>LT</sup> should only be charged in non-hazardous environments.

To charge your TIGER<sup>LT</sup>, connect the Charge Cradle to the mains. A red light on the charger indicates that it is ready. Place the TIGER<sup>LT</sup> in the Charge Cradle so that the contacts on the TIGER<sup>LT</sup> are aligned with those in the cradle. There is no need to remove the Instrument Boot from the TIGER<sup>LT</sup>.



LED Colour	Meaning
RED	Power connected, not charging.
AMBER	Instrument charging.
GREEN	Instrument fully charged.

The battery icon on the TIGER<sup>LT</sup> will display the level of charge:



Battery empty

When the battery is nearly empty, the icon will flash for one minute before the instrument shuts down.

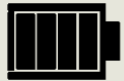

Battery fully charged



Only use the Charge Cradle supplied with your TIGER<sup>LT</sup>.



ION Science Ltd recommends keeping your TIGER<sup>LT</sup> on charge at all times when not in use, as batteries can lose power over time.

### Replacement of Rechargeable Battery Packs



**Battery Use: Use supplied battery packs only on the TIGER<sup>LT</sup>.**

To replace the Rechargeable Battery Pack:

1. Ensure TIGER<sup>LT</sup> is switched Off.
2. Remove the Instrument Boot:



3. Release the clip at the rear of the instrument and lift the Rechargeable Battery Pack away from the Instrument Body while sliding it slightly backwards:

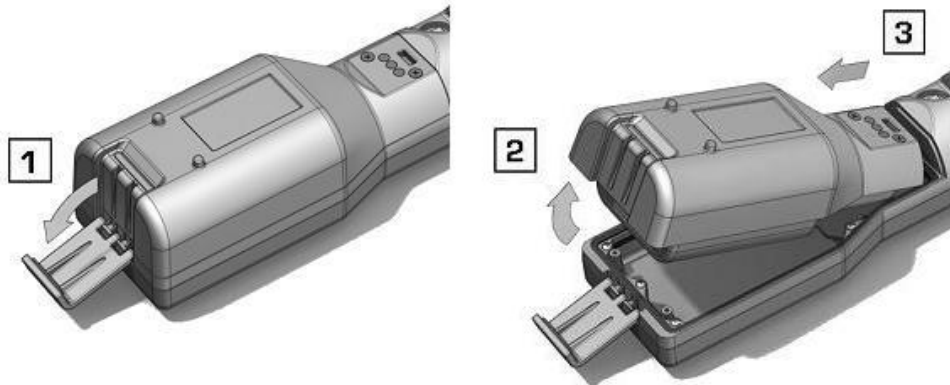

4. Reverse the previous step to slide the replacement battery pack into the Instrument Body and secure it using the clip.
5. Replace the Instrument Boot ensuring that it is snug around the front of the Instrument Body and the lights are not obscured.
6. Charge the TIGER<sup>LT</sup> for 7 hours before use.

### Replacement of Non-rechargeable Batteries



**BATTERY REPLACEMENT: NEVER REPLACE PRIMARY ALKALINE BATTERY CELLS WHILE IN A POTENTIALLY EXPLOSIVE OR HAZARDOUS LOCATION. USE ONLY INDUSTRIAL BY DURACELL ID1500 BATTERIES.**



**Fitting batteries or connecting the Battery Pack with the wrong polarity may result in damage to the instrument.**

1. Ensure TIGER<sup>LT</sup> is switched Off.
2. Remove the Instrument Boot (see [Replacement of Rechargeable Battery Packs](#)).
3. Remove the AA Battery Pack.
4. Remove the screws retaining the battery cover and lift it off. This reveals the batteries in the Battery Holder.
5. Remove the Battery Holder.
6. Replace the batteries. Use Industrial by Duracell ID1500 batteries.
7. Check that the polarity of the batteries is correct. Replace the Battery Holder.
8. Refit the battery cover and the securing screws.

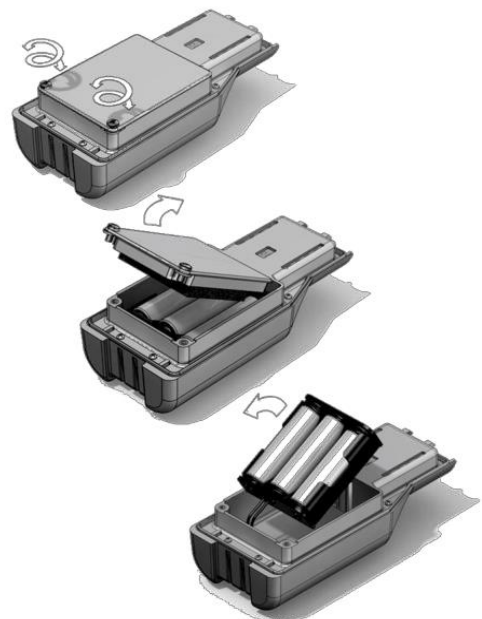

- Replace the Instrument Boot ensuring that it is snug around the front of the Instrument Body and the lights are not obscured.



#### WEEE REGULATIONS

Dispose of used batteries in accordance with all local and national safety and environmental requirements.

### Inlet Probe Assembly

All parts of the probe assembly can be replaced if they become damaged or contaminated with use.

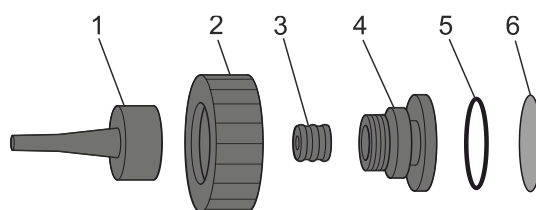

- |                      |                    |
|----------------------|--------------------|
| 1 Inlet Probe        | 4 Filter Clamp     |
| 2 Filter Housing Cap | 5 O-ring           |
| 3 Probe Seal         | 6 PTFE Filter Disc |

### PTFE Filter Disc



It is essential that the TIGER<sup>LT</sup> is always used with a supplied 0.5 micron PTFE Filter Disc fitted to the front of the instrument. Without the filter, particles of debris and dust can be drawn into the MiniPID 2 Sensor inhibiting the function of the instrument. These filters are consumable and should be changed after every 100 hours of use. The frequency of replacement should be increased for dusty or moisture laden environments. PTFE Filter Discs are available from your distributor or at [www.ionscience.com](http://www.ionscience.com).

PTFE Filter Disc changing should be conducted in a suitably clean environment, with clean hands and equipment to avoid contamination of the new PTFE Filter Disc.

To change the PTFE Filter Disc (see the [Inlet Probe Assembly](#)):

- Unscrew the Filter Housing Cap and lift off the Filter Clamp and O-ring.
- Lift the PTFE Filter Disc from the Instrument Body. Carefully place a new PTFE Filter Disc into the Instrument Body.

*Under no circumstances should a PTFE Filter Disc be used once it has been removed.*

- Replace the Filter Clamp, ensuring that the O-ring is correctly seated.
- Replace the Filter Housing Cap. Do not over-tighten.

### Probe Seal

The Probe Seal (see the [Inlet Probe Assembly](#)) should be inspected and replaced when required.

## Water Ingress

If the instrument has been immersed or splashed with water, take the PID 2 Sensor out to dry (see below) and replace the PTFE Filter Disc as described previously.

## Lamp Cleaning and Electrode Stack Replacement



**The TIGER<sup>LT</sup> is a sensitive detector. Internal components must be handled with clean hands and clean tools. The Lamp is fragile. Handle with great care. Never touch the window and do not drop.**

### When to Clean or Replace the Lamp

The TIGER<sup>LT</sup> MiniPID uses an ultraviolet light source ionising VOC gases as they pass across the Lamp window. This process may result in a fine layer of contamination on the detector window that must be removed on a regular basis.

- In normal use the Lamp should be cleaned after every 100 hours (based on 30 ppm for 100 hours). If the Tiger<sup>LT</sup> is used in heavily gas contaminated environments, the Lamp should be cleaned more often.
- Please note that some esters, amines and halogenated compounds may accelerate window fouling; in these cases cleaning may be required after every 20 hours of use.
- Cleaning frequency will also depend upon alarm levels set and prevailing environmental conditions.
- Damaged Lamps must be replaced immediately. Do not use a Tiger<sup>LT</sup> with a damaged Lamp.

### When to Replace the Electrode Stack

When using your Tiger<sup>LT</sup> in conditions of high ambient humidity, it may show unexpected and increasing readings. This is due to dust or other small particles within the detector becoming hydrated which causes these particles to conduct a signal between the electrodes.

The problem can be resolved by replacing the Electrode Stack.

### Removing the MiniPID 2 Sensor



**Protect the MiniPID 2 Sensor from exposure to silicone vapours as this may foul the windows of the Lamps and reduce response to some gases. This can usually be remedied by polishing the Lamp window with alumina powder.**



**Do not remove the MiniPID 2 Sensor Cover in the hazardous area.**

Before Lamp cleaning or replacement, the the MiniPID 2 Sensor must be removed.

First ensure that the TIGER<sup>LT</sup> is turned off and that you are in a clean environment so that the sensor parts will not be contaminated by dust, oil or grease.



On the Sensor Cover loosen the centre screw turning it with a small coin or a suitable flat bladed screwdriver and remove the Sensor Cover.

Ensure that the Sensor Seal, on the inside of the Sensor Cover is not disturbed.

Carefully lift the MiniPID 2 Sensor from the Instrument Body, ensuring that the two Inlet/Outlet Seals remain in place in the Instrument Body.



Using the Mini PID Electrode Stack Removal Tool provided, locate its 'prongs' in the slots in the side of the Mini PID 2 Sensor body:

Using the forefinger to restrain the white Electrode Stack (the internal parts of the MiniPID 2 Sensor are spring-loaded), squeeze the Removal Tool to release the Electrode Stack.

At this point the [MiniPID Electrode Stack can be replaced](#).

## Lamp Removal and Examination



**The TIGER<sup>LT</sup> is a sensitive detector. Internal components must be handled with clean hands and clean tools. The TIGER Lamp is fragile. Handle with great care. Never touch the window and do not drop.**

Following removal of the Electrode Stack as described previously, the Lamp may now be removed.

Carefully remove the Lamp:

- If the Lamp is held in the Electrode Stack, carefully pull it out of the O-ring around the well in the underside of the Electrode Stack.
- If the Lamp is sitting in the sensor body - the Lamp can be gripped and lifted out or the sensor body can be inverted and the Lamp tipped out.



Inspection of the Lamp may reveal a layer of contamination on the detection window. This appears as a 'blue hue.' To check for this, hold the Lamp in front of a light source and look across the window surface at an angle.

If necessary, clean the Lamp.

## Lamp Cleaning

Clean the window using the PID Lamp Cleaning Kit supplied.



**THE LAMP CLEANING COMPOUND CONTAINS ALUMINIUM OXIDE AS A VERY FINE POWDER. THIS MAY CAUSE IRRITATION OF RESPIRATORY TRACT AND EYES. (CAS Number 1344-28-1).**

A full material safety data sheet MSDS is available on request from ION Science Ltd. The key issues are listed below.

### Handling:

- Do not breathe vapour/dust. Avoid contact with skin, eyes and clothing.
- Wear suitable protective clothing.
- Follow industrial hygiene practices: Wash face and hands thoroughly with soap and water after use and before eating, drinking, smoking or applying cosmetics.
- The Compound has a TVL (TWA) of 10 mg/m<sup>3</sup>.

### Storage:

- Always replace the lid after using the cleaning compound.
- Keep container closed to prevent water adsorption and contamination.

The cleaning procedure is as follows:

1. Open the vial of Aluminium Oxide polishing compound. With a clean cotton bud collect a small amount of compound.
2. Use this cotton bud to polish the Lamp detection window. Use a circular action applying light pressure to clean the detection window. Never touch the detection window with fingers.



3. Continue polishing until an audible “squeaking” is made by the cotton bud with compound moving over the window surface (usually within fifteen seconds).
4. Remove the residual powder with a short blast of air from the can of clean, dry, oil free air.
5. Refit the Lamp into the Electrode Stack as described previously.

### Replacing a Lamp



**Never refit a damaged Lamp.**



**The instrument MUST be re-calibrated after fitting a replacement or cleaned Lamp.**

Following removal of the Electrode Stack as described previously, the Lamp may be replaced.

Carefully remove the Lamp:

- If the Lamp is held in the Electrode Stack, carefully pull it out of the O-ring around the well in the underside of the Electrode Stack.
- If the Lamp is sitting in the sensor body - the Lamp can be gripped and lifted out or the sensor body can be inverted and the Lamp tipped out.

Discard the removed (old) Lamp.

At this point the [MiniPID Electrode Stack can be replaced](#).

### Replacing the MiniPID Electrode Stack

At this point the MiniPID Electrode Stack can be replaced.

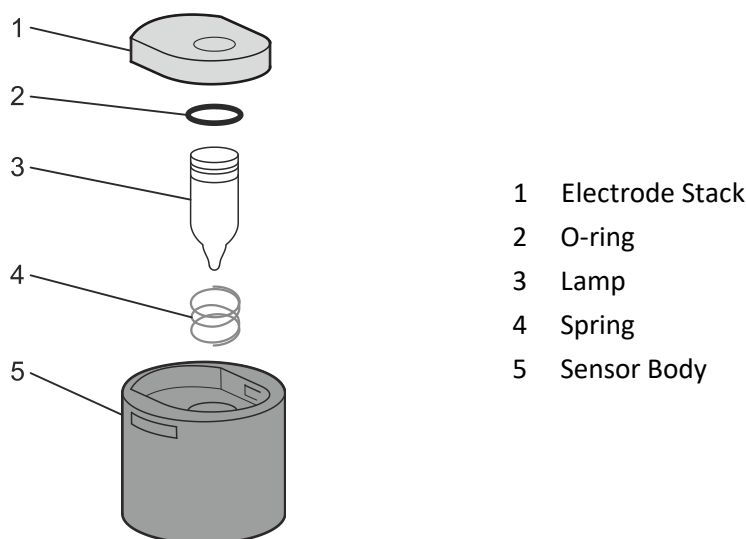

Discard the removed (old) Electrode Stack, carefully removing the Lamp if still attached.

Visually check the condition of the Lamp detection window (the upper flat surface of the Lamp). If this needs cleaning, proceed as detailed later.

Place the Electrode Stack onto a clean, flat surface, flat surface downwards. Carefully twist the detection window end of the Lamp into the O-ring around the well in the underside of the Electrode Stack. The Lamp window should now sit flush within the Electrode Stack.



This procedure ensures that the Lamp is firmly held in the Electrode Stack with the detection window level with the electrodes for consistent and reliable VOC readings. Lamp placement by any other means is likely to give unreliable readings because the O-ring in the Electrode Stack becomes trapped between the window face and the Electrode Stack.

Carefully align the MiniPID 2 Sensor body over the Electrode Stack plus Lamp. Push the sensor body down to secure the assembly - two clicks should be heard.

Carefully align/push the new MiniPID 2 Sensor into the Instrument Body.

Then ensuring, the PTFE Filter Disc and O-ring are correctly positioned, screw the Sensor Cover back onto the Instrument Body. Do not over-tighten.

The instrument MUST now be re-calibrated.

## 9. Troubleshooting

### Diagnosics

Basic faults or diagnostics are presented as symbols. Most faults can be corrected by pressing **Enter** or **Esc** to clear the fault message. All fault conditions cause the TIGER<sup>LT</sup> to alarm.

#### Pump failure



#### ***Pump blocked or pump failure***

The flow of gas through the instrument has fallen below 50cc/minute. Check the Probe and PTFE Filter Disc for signs of blockage. Water or dirt in the Probe, a bent Probe, dirty PTFE Filter Disc on the inlet or blockage of the exhaust can all cause low flow. If the blockage can be removed, press **Esc** to clear the alarm. If the fault persists send the instrument to your distributor for service.

#### Battery dead

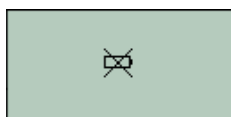

#### ***Battery low or battery failure***

The TIGER<sup>LT</sup> will shut down when the battery level falls below 2%. Recharge the battery as instructed in the [Batteries](#) section of this manual ensuring that all connections are sound and the indicator lights on the charger are in order. If the battery fails to charge, fit another battery pack if available. If using alkaline batteries, replace them. If the fault persists send the instrument and charger to your distributor for service.

#### Lamp out



#### ***Lamp failure***

The PID Lamp has failed to strike (illuminate); this may occur at switch on or during use. Try switching the TIGER<sup>LT</sup> off and on. If this fault persists then the electrode stack or lamp should be replaced. (See the [PID Sensor/Lamp Replacement and Cleaning](#) section).

#### Memory full



#### ***Memory cannot receive more data***

The data log memory is full. This will only happen if the Log Full box is set to 'alarm' on the Tiger<sup>LT</sup>PC configuration screen. Press the **Esc** key to continue, but the TIGER<sup>LT</sup> will no longer continue to log data. Select 'recycle' in Tiger<sup>LT</sup>PC and the TIGER<sup>LT</sup> will overwrite the oldest data and no alarm will be raised.

#### System error



#### ***Total system failure***

The instrument's firmware is corrupted. In the unlikely event of this message appearing, contact ION Science Ltd or your nearest authorised service centre.

## 10. Appendix and Supporting Documents

### EU Declaration of Conformity

The EU Authorised Representative of the manufacturer Ion Science limited has sole responsibility, on the date this product accompanied by this declaration is placed on the market, the product conforms to all technical and regulatory requirements of the listed directives

**Authorised Representative:** ISM Deutschland GmbH · Laubach 30 · D-40822 Mettmann, Germany

**Product:** PhoCheck TIGER

**Product description:** Intrinsically safe photo-ionisation gas detector for detecting volatile organic compounds

**Directive:** ATEX Directive (2014/34/EU)  
EMC Directive (2014/30/EU)

**Type of protection:**



II 1 G Ex ia IIC T4 Ga  
T<sub>amb.</sub> = -15°C to +45 °C (with Lithium ion Battery Pack)  
T<sub>amb.</sub> = -15 °C to +40 °C (with Alkaline Battery Pack)

**Certificate Number:** ITS09ATEX26890X

**Notified body:** Intertek, 2575, Miglioli, Italy

**North American certifying authority:** Intertek:

**North American File#:** 102394781CHE-001



**Standards:**

**EN IEC 60079-0: 2018** Electrical apparatus for explosive gas atmospheres. General requirements

**EN IEC 60079-11: 2012** Explosive atmospheres. Equipment protection by intrinsic safety "i"

**EN 61326-1:2006** Electrical equipment for measurement, control and laboratory use - EMC requirements. Group 1, Class B equipment - (emissions section only)

**EN 61326-1:2006** Electrical equipment for measurement, control and laboratory use - EMC requirements. Industrial location immunity - (immunity section only)

**EN 50270:2006** Electromagnetic compatibility - Electrical apparatus for the detection and measurement of combustible gases, toxic gases or oxygen. Immunity Type 2 - industrial environments.

**Other Standards:**

**EN ISO/IEC 9001:2015** Quality Management System – Requirements

**EN ISO/IEC 80079-34 :2020** Potentially Explosive Atmospheres – Application of Quality Systems

**Name:** Clemens A. Verley

**Position:** Chief Executive Officer



**Signature:**

**Date:** 31<sup>st</sup> December 2020

## Technical Specifications

<b>Minimum Resolution</b>	0.1 ppm
<b>Detectable Range</b>	0 ppm to 5,000 ppm
<b>Response Time</b>	T90 < 2 seconds
<b>Accuracy</b>	± 5% display reading ± one-digit (at calibration point)
<b>Intrinsically Safe Approvals</b>	<ul style="list-style-type: none"> <li>•  II 1G Ex ia IIC T4 Ga</li> <li>• Tamb = - 15 oC ≤ Ta ≤ +45 oC (with Lithium ion Battery Pack)</li> <li>• Tamb = - 15 oC ≤ Ta ≤ +45 oC (with Alkaline Battery Pack)</li> <li>• ITS09ATEX26890X IECEx ITS 10.0036X</li> <li>• 3193491 conforms to UL Std. 913, 61010-1 &amp;</li> <li>• Certified to CAN/CSA Std. C22.2 No. 61010-1</li> </ul>
<b>Battery Life</b>	<p><b>Li-ion:</b></p> <ul style="list-style-type: none"> <li>• up to 24 hours</li> <li>• charge time 6.5 hours</li> </ul> <p><b>Alkaline 3 x AA:</b></p> <ul style="list-style-type: none"> <li>• typically 8.5 hours life</li> </ul>
<b>Lamps</b>	<ul style="list-style-type: none"> <li>• 10.6eV krypton (standard)</li> </ul>
<b>Data Log</b>	<ul style="list-style-type: none"> <li>• Including date / time: 80,000</li> </ul>
<b>Communication</b>	Direct USB 1.1
<b>Calibration</b>	2- and 3-point calibration (via calibration kit accessory)
<b>Alarms</b>	<ul style="list-style-type: none"> <li>• Flashing LED's amber (low alarm) red (high alarm)</li> <li>• Sounder 95 dBA at 300 mm (12")</li> <li>• Vibration on alarm</li> </ul>
<b>Flow Rate</b>	≥ 220 ml/min
<b>Temperature –</b>	<p><b>Operating:</b></p> <ul style="list-style-type: none"> <li>• -20 to 60°C / -4 to 140°F (non-Intrinsically Safe environment)</li> </ul> <p><b>Certified to:</b></p> <ul style="list-style-type: none"> <li>• 15 to +45°C / +5 to +113°F (Intrinsically Safe environment)</li> </ul> <p><b>Storage:</b></p> <ul style="list-style-type: none"> <li>• -25 to 60°C / -5 to 140°F</li> </ul> <p><b>Humidity:</b></p> <ul style="list-style-type: none"> <li>• 0-99% RH (non-condensing)</li> </ul>

**Weight & dimensions -****Instrument weight:** 0.75 kg**Size:** 465 mm (18.3") H x 89 mm (3.5") W x 61 mm (2.4") D**Warranty**

Standard Warranty can be extended to up to 2 years on the TIGER<sup>LT</sup> when registering your instrument via our website: [www.ionscience.com](http://www.ionscience.com)

To receive your Extended Warranty, you need to register within one month of purchase (Terms and Conditions apply). You will then receive a confirmation email that your Extended Warranty Period has been activated and processed.

Full details, along with a copy of our Warranty Statement can be found by visiting: [www.ionscience.com](http://www.ionscience.com)

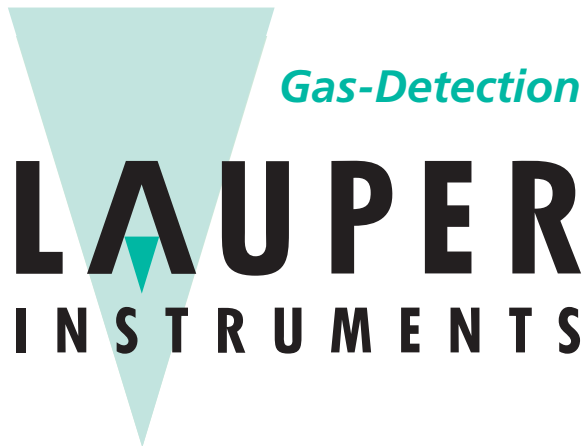

**Lauper Instruments AG**

Irisweg 16 B

CH-3280 Murten

Tel. +41 26 672 30 50

[info@lauper-instruments.ch](mailto:info@lauper-instruments.ch)

[www.lauper-instruments.ch](http://www.lauper-instruments.ch)



Manual Log

Manual version	Amendment	Issue Date	Instrument Firmware	PC Software
V1.0	Manual created	16/06/15	V0.5.02	V1.1.0.2
V1.1	Reference to survey mode removed (page8) Part number descriptions updated (page37)	18/09/15	V0.5.09	V1.1.0.3
V1.2	New probe design. Pages 33, 36 and 37	27/01/2016	V0.5.09	V1.1.0.3
V1.3	Warranty length updated	18/02/2016	V0.5.09	V1.1.0.3
V1.4	Part number update on diagram - page 36 Declaration of Conformity – page 5 MiniPID to MiniPID2 throughout – throughout. US postal address page 39 Statement page 7 Minor text refinement throughout	13/06/2016	V0.5.09	V1.1.0.3
V1.5	Cover image updated - page 1 Display range - page 11 Zero statement - page 22 Cal times to 30 secs - Page 32 & 33 Part descriptions – page 34, 37 Updated exploded diagram - page 36 Dimension corrected - page 40 dBA distance to mm - page 40 Disclaimer added – page 41	30/11/2016	V0.5.09	V1.1.0.3
V1.6	All Reference to TIGER <sup>LT</sup> in Warnings/official text all changed to PhoCheck Tiger Updated Battery replacement information Updated EU Declaration of Conformity Text changes on pp 9 (Turn Off), 11 (Screen Display, Memory Status, Battery Status), 13 (Soft Key Areas), 15 (Custom Calibration) 17 Tiger PC <sup>LT</sup> software installation, 18 The Help Screen, 23 Zero tracking, 32 Diagnostics Section, 34 Maintenance Section – new part nos. on diagram, 25 Lamp replacement section, 38 846216, removed A-861415 delete, A861267	23/08/2018	V0.5.09	V1.1.0.3



V1.7	Page numbers amended, PPM amendment to custom calibration section (p34), Temperatures updated on Technical Spec (p41)	14/03/2019	V0.5.09	V1.1.0.3
V1.8	Page layout adjustments, updated Tiger LT PC screenshots	06/07/2020	V0.5.12	V1.1.0.10
V1.8R	Declaration of conformity update	09/12/2020	V0.5.12	V1.1.0.10