



Please fill out the form(s) below for each instrument that has been purchased.

Use this information when contacting Michell Instruments for service purposes.

Product Name	
Order Code	
Serial Number	
Invoice Date	
Installation Location	
Tag Number	

Product Name	
Order Code	
Serial Number	
Invoice Date	
Installation Location	
Tag Number	

Product Name	
Order Code	
Serial Number	
Invoice Date	
Installation Location	
Tag Number	



## Optidew

For Michell Instruments' contact information please go to  
[www.michell.com](http://www.michell.com)

© Michell Instruments 2020

This document is the property of Michell Instruments Ltd and may not be copied or otherwise reproduced, communicated in any way to third parties, nor stored in any Data Processing System without the express written authorization of Michell Instruments Ltd.

---

## Contents

Safety .....	viii
Warnings.....	viii
Electrical Safety .....	ix
Pressure Safety.....	ix
Hazardous Materials (WEEE, RoHS3 & REACH) .....	ix
Calibration (Factory Validation) .....	ix
Repair and Maintenance .....	ix
Abbreviations.....	x
<b>1. INTRODUCTION .....</b>	<b>1</b>
1.1. Optidew Series.....	1
1.2. Optidew Sensor .....	2
1.3. Minimum Measurable Dew Points .....	3
1.4. Remote Temperature Probes.....	4
<b>2. INSTALLATION.....</b>	<b>5</b>
2.1. Unpacking the instruments.....	5
2.2. Mounting.....	5
2.3. Instrument Connections.....	7
2.3.1. Optidew 501 .....	7
2.3.2. Optidew 401 .....	8
2.4. Electrical Connections.....	9
2.4.1. Electrical Supply .....	9
2.4.2. Analog and Digital Communications.....	10
2.5. Sensor Installation .....	13
2.5.1. Environmental monitoring .....	13
2.5.2. Monitoring a flowing sample .....	13
2.5.3. Environmental Chamber or Glovebox sensor mounting.....	14
2.6. Temperature Probe Installation .....	14
2.6.1. Using Temperature Probes with a chamber port adapter .....	15
2.7. Pressure Transmitter Installation .....	15
<b>3. USER INTERFACE .....</b>	<b>16</b>
3.1. Main Display .....	16
3.1.1. Full Screen Mode .....	16
3.1.2. Main Screen .....	17
3.1.3. Customizable Readouts .....	18

3.1.4. Locking the analyzer .....	18
3.1.5. Menu Structure.....	19
3.1.6. Operational Status Display.....	20
3.1.7. Sensor Status Display.....	21
3.2. Setup Menus.....	22
3.2.1. DCC.....	22
3.2.2. Logging .....	24
3.2.3. Outputs .....	25
3.2.4. Alarm .....	26
3.2.5. Display .....	27
3.2.6. Clock .....	28
3.2.7. Inputs .....	29
3.2.8. Comms Screen .....	30
3.2.9. Network Settings .....	30
3.3. Optidew 501 Transmitter without display .....	31
3.3.1. Optics Calibration .....	31
<b>4. OPERATION.....</b>	<b>32</b>
4.1. Operating Cycle .....	32
4.2. Operating Guide.....	33
4.2.1. Description.....	33
4.2.2. Operating Practice .....	33
4.3. Good Measurement Practice.....	36
4.3.1. Sampling Hints .....	36
4.3.2. First Time Operation .....	39
4.4. Operational Functions.....	39
4.4.1. DCC Function .....	39
4.4.2. MAXCOOL Function.....	40
4.4.3. Frost Assurance Technology (FAST) .....	40
4.4.4. STANDBY Mode .....	41
4.4.5. Parameter Conversions & Pressure Compensation .....	41
4.4.6. Data Logging.....	42
<b>5. WARNINGS AND FAULTS.....</b>	<b>42</b>
<b>6. MAINTENANCE .....</b>	<b>44</b>
6.1. Mirror Cleaning .....	44
6.2. Exchanging Sensors .....	45

## Appendices

<b>Appendix A</b> .....	<b>46</b>
Technical Specifications.....	47
<b>Appendix B</b> .....	<b>49</b>
Modbus Register Map.....	50
Further Reading.....	58
<b>Appendix C</b> .....	<b>59</b>
Legacy Serial Protocol .....	59
C.1 Legacy Mode .....	60
C.2 Hardware Connection .....	60
C.3 Changing between Modbus and Legacy Mode.....	61
C.4 Emulated Legacy Commands .....	62
C.5 New Commands for Optidew 401-501.....	64
<b>Appendix D</b> .....	<b>65</b>
Dimensional Drawings.....	66
<b>Appendix E</b> .....	<b>73</b>
Quality, Recycling, Compliance & Warranty Information .....	74
<b>Appendix F</b> .....	<b>75</b>
Return Document& Decontamination Declaration .....	76

## Figures

Figure 1 Optidew 501 (wall mount) and Optidew 401 (bench top)	1
Figure 2 2-Stage minimum measureable dew point	3
Figure 3 General Purpose Probe	4
Figure 4 Labatory/High Temperature Probe	4
Figure 5 Optidew 501 wall mounting points	6
Figure 6 Optidew 501 with Touch Screen display or DCC control button	7
Figure 7 Optidew 501 bottom panel	7
Figure 8 Optidew 401 front and side panels	8
Figure 9 Optidew 401 rear panel	8
Figure 10 Power Connector	9
Figure 11 RS458 & Analog output connector	10
Figure 12 Analog output connector	11
Figure 13 Relay contact connector	12
Figure 14 Temperature Probe Adapter	15
Figure 15 Main Screen	16
Figure 16 Main Screen layout	17
Figure 17 DCC Menu	22
Figure 18 Logging Screen	24
Figure 19 Outputs Screen	25
Figure 20 Alarm Screen	26
Figure 21 Display Screen	27
Figure 22 Clock Screen	28
Figure 23 Inputs Screen	29
Figure 24 Comms Screen	30
Figure 25 Network Settings Screen	30
Figure 26 Typical Operating Cycle	32
Figure 27 Room Measurement Example	34
Figure 28 Mirror Contaminaton Warning Symbol	35
Figure 29 Material Permeability Comparison	36
Figure 30 Condensation in Sample Tubing	37
Figure 31 System alarm	42
Figure 32 Sensor Cleaning	44

## Safety

The instrument is designed to be completely safe when installed and operated correctly in accordance with the information provided in this manual.

This manual contains all the required information to install, operate and maintain this product. Prior to installation and use of this product, this entire manual should be read and understood. Installation and operation of this product should be carried out by suitably competent personnel only. The installation and operation of this product must be in accordance with the instructions provided and according to the terms of any associated safety certificates. Incorrect installation and use of this product other than those described in this manual and other than its intended purpose will render all warranties void.

This product meets the essential protection requirements of the relevant EU directives. Further details of applied directives may be found in the product specification.

Electricity and pressurized gas can be dangerous. This product must be installed and operated only by suitable trained personnel.



**No user serviceable parts inside**

## Warnings



**Where this hazard warning symbol appears in the following sections, it is used to indicate areas where potentially hazardous operations need to be carried out and where particular attention to personal and personnel safety must be observed.**



**Where this symbol appears in the following sections it is used to indicate areas of potential risk of electric shock.**

## **Electrical Safety**

Ensure electrical safety is complied with by following the directions provided here and observing all local operation & installation requirements at the intended location of use.

This product is completely safe when using any options and accessories supplied by the manufacturer of this product for use with it. Refer to Section 2 (Installation) of this manual for further details.

## **Pressure Safety**

For this product to operate satisfactorily, pressurized gas must be connected to it. Observe all the information contained within this manual and all local operation & installation requirements at the intended location of use. Refer to Section 2 (Installation) of this manual for further details.

## **Hazardous Materials (WEEE, RoHS3 & REACH)**

This product does not contain or release any prohibited chemicals listed on the SVHC (Substances of Very High Concern) Candidate List. During the intended normal operation of this product it is not possible for the user to come into contact with any hazardous materials. This product is designed to be recyclable except where indicated.

## **Calibration (Factory Validation)**

Prior to shipment, the instrument undergoes stringent factory calibration that is traceable to national standards. Due to the inherent stability of the instrument, regular factory calibration is not required, however recalibration is recommended to maintain measurement traceability.

Michell Instruments can provide a fully traceable factory calibration service for the instrument and it is recommended that this is considered at intervals of every year of the analyzer's life. Please contact your local Michell Instruments office or representative for further details ([www.michell.com](http://www.michell.com)).

## **Repair and Maintenance**

Apart from user-replaceable components required for routine operational maintenance described above, the instrument must only be maintained either by the manufacturer or an accredited service agent. Refer to [www.michell.com](http://www.michell.com) for details of Michell Instruments' worldwide offices contact information.

## Abbreviations

The following abbreviations are used in this manual:

A	ampere
AC	alternating current
atm	pressure unit (atmosphere)
bara	pressure unit (=100 kP or 0.987 atm) absolute
barg	pressure unit (=100 kP or 0.987 atm) gauge
°C	degrees Celsius
°F	degrees Fahrenheit
EU	European Union
hr	hour
Hz	Hertz
IEC	International Electrotechnical Commission
IP	Internet protocol
ml/min	milliliters per minute
mg/m <sup>3</sup>	milligrams per cubic meter
lbs/MMscf	pounds per million standard cubic feet
mA	milliampere
mins	minutes
mmHg	millimeter of mercury
Pa	pascal
ppmv	parts per million (by volume)
ppmw	parts per million (by weight)
%Vol	percentage volume
psia	pound(s) per square inch (absolute)
psig	pound(s) per square inch (gauge)
RH	relative humidity
RS485/232	standards defining the electrical characteristics of drivers & receivers
RTC	real time clock
RTU	Remote Terminal Unit
SD	storage device card
UART	universal asynchronous receiver/transmitter
USB	Universal Serial Bus
V	Volts
"	Inch
Δ	delta
%	percentage
Ω	ohms

## 1. INTRODUCTION

The Optidew chilled mirror hygrometer is based on the proven, fundamental condensation temperature dew point principle, giving unmatched long-term drift-free performance.

Michell offers three highly durable sensor options, which are suitable for measuring in a wide variety of different samples.

### 1.1. Optidew Series

The Optidew 501 features a compact ABS enclosure with an aluminium base plate and 4 external lugs for easy mounting to a panel or wall. It is available with a 5.7" touch screen display, or as a "transmitter only" version.

A weatherproof version of the Optidew 501 enclosure is available with a modified connector panel to improve ingress protection to IP65. Note that the Ethernet and SD card options are not available in combination with the weatherproof version.

The Optidew 401 is designed to be easy to handle and transport and is ideal for laboratory or service use. It has a 5.7" touch screen LCD fitted as standard.



*Figure 1 Optidew 501 (wall mount) and Optidew 401 (bench top)*

## 1.2. Optidew Sensor

The new Optidew sensor is available with either a single or dual stage thermoelectric cooler and with a choice of sensor head materials making it suitable for use in air/inert gases or in corrosive environments. The following tables show the capabilities of each sensor type:

	<b>Single Stage Sensor</b>	<b>Dual Stage Sensor</b>	<b>Harsh Environment Sensor</b>
Approximate maximum depression at ambient	60 °C 140 °F	70 °C 158 °F	70 °C 158 °F
Maximum operating temperature	90 °C 194 °F	90 °C 194 °F	120 °C 248 °F
Maximum Recommended Sensor Temperature for FAST	21 °C 70 °F	30 °C 86 °F	30 °C 86 °F
<b>Lowest Measurable Dew Point</b>			
Sensor temperature at 23 °C ambient	-25 °C -13 °F	-40 °C -40 °F	-40 °C -40 °F

For more detailed information on the performance of the sensor across its whole operating temperature range, see below. All versions are rated for use at pressure up to 2500 kPag (362 psig).

### 1.3. Minimum Measurable Dew Points

The minimum dew point that can be measured is determined by the sensor temperature, and whether the sensor can be maintained at that temperature. The following chart assumes operation in a climatic chamber, where the air speed is sufficient to remove any excess heat generated by the sensor.

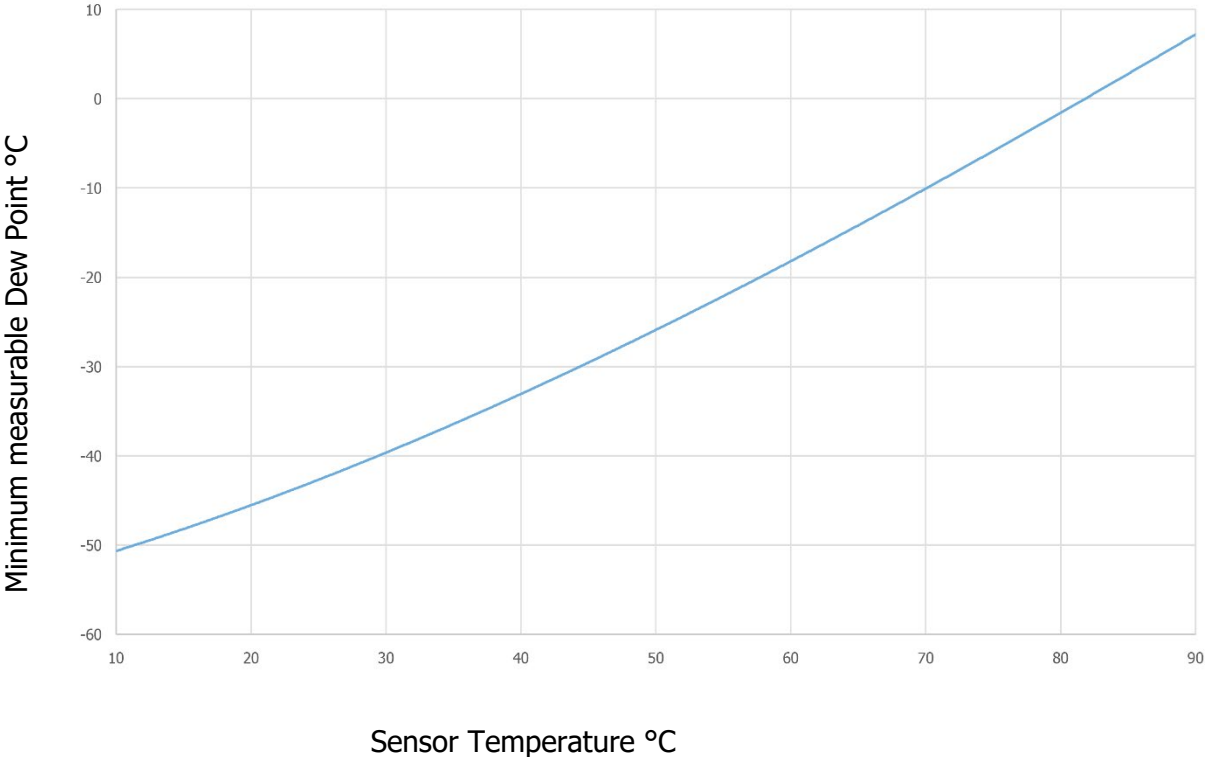

Figure 2 2-Stage minimum measurable dew point

## 1.4. Remote Temperature Probes

Two versions of temperature probe are available for the Optidew: a general-purpose probe rated to +90 °C (+194 °F), and a laboratory/high-temperature probe rated to +120 °C (+248 °F).

### General-Purpose Probe

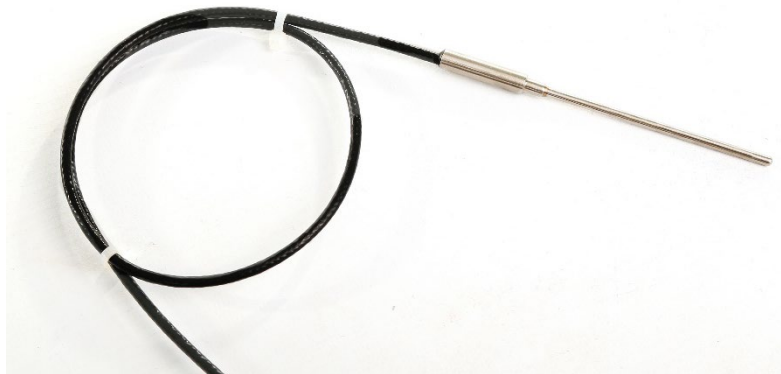

*Figure 3 General Purpose Probe*

This 75mm (3") probe is supplied when any of the 'standard' sensor cable options are selected. It is intended to be installed in its entirety into the environment to be measured.

An M12 plug is integrated into the probe itself to connect to the supplied cable.

### Laboratory/High Temperature Probe



*Figure 4 Laboratory/High Temperature Probe*

This 50mm (1.97") probe is supplied when any of the high temperature cable options are selected, however it is also designed specifically for compatibility with Michell Instruments or Rotronic humidity calibration chambers.

The probe is fitted with a 0.5m (1.64 ft) flying lead with an M12 plug to simplify connection into a calibration chamber. The chosen cable length option is still supplied.

## 2. INSTALLATION

### 2.1. Unpacking the instruments

It is recommended that all packaging is retained, in case products are returned for service or calibration. Alternatively, if you choose to dispose of the packaging materials, ensure they are recycled in accordance with local legislation.

Standard contents in the box:

- Calibration Certificate
- 6-Way Alarm Relay Connector
- 8-Way Analogue Output / RS485 Connector
- Pt100 Temperature Probe (with separate or integrated M12 cable, depending on model)
- Chilled Mirror Monitor
- Chilled Mirror Sensor
- Chilled Mirror Sensor Cable
- Mains Cable

### 2.2. Mounting

#### **Optidew 401**

The Optidew 401 is designed to be placed on a bench or table during operation. Alternatively, it can be used inside the optional Transport Case.

#### **Optidew 501**

The Optidew can be wall mounted using the four mounting points on each corner (see Figure 2 for mounting point dimensions). It is possible to install the Optidew 501 outside, providing it is shielded from direct sunlight and the climate is within the environmental requirements listed in Appendix A Technical Specifications. It is highly recommended to choose the weatherproof option if the installation will be outdoors.

#### **Fixings**

Secure using 4 off suitable screws or bolts plus washers (M4 x 15 to M6 x 15mm). Unit must be secured to a solid surface (e.g. brick, concrete, wood minimum 10mm/0.39" thick) or to a metal chassis plate of minimum 3mm (0.12") thickness.

**Wall Mounting Points**

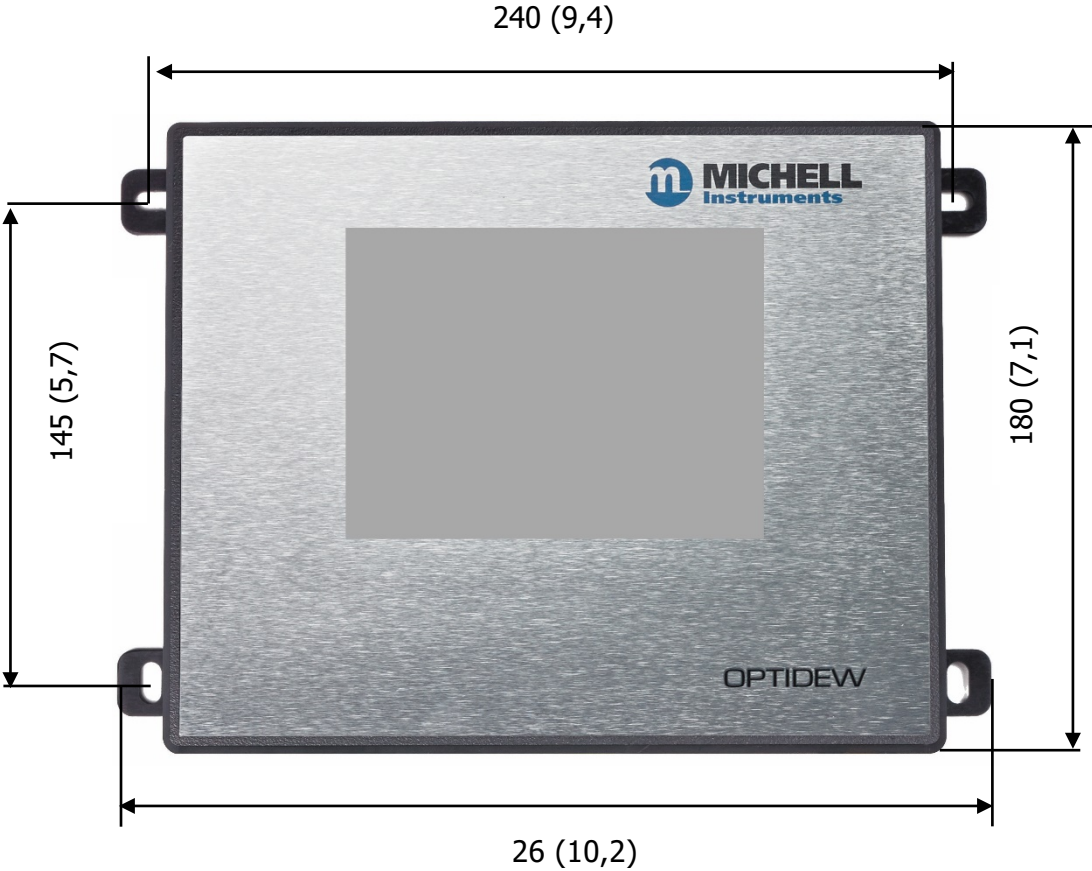

*Figure 5 Optidew 501 wall mounting points*

## 2.3. Instrument Connections

### 2.3.1. Optidew 501

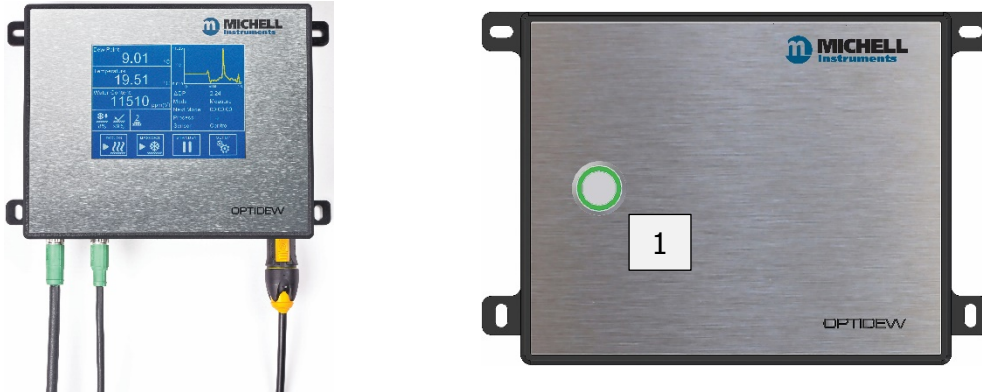

Figure 6 Optidew 501 with Touch Screen display or DCC control button

Number	Description
1	DCC Control/ Status indicator
2	Sensor Cable connector
3	Temperature probe cable connector
4	Pressure transmitter cable connector
5	Alarm contacts connector
6	RS485 and analog output connector
7	SD Card slot (optional)
8	Ethernet port (optional)
9	Power Connector

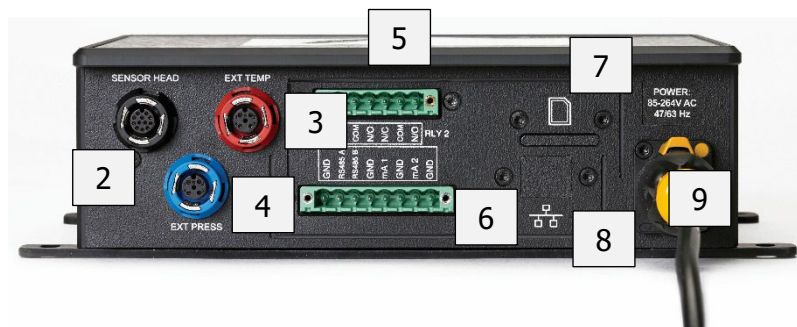

Figure 7 Optidew 501 bottom panel

2.3.2. Optidew 401



Figure 8 Optidew 401 front and side panels

Number	Description
1	Power Connector
2	Power Switch
3	SD card slot
4	Alarm contacts connector
5	RS485 and analog output connector
6	USB port
7	Ethernet port (optional)
8	Sensor Cable connector
9	Temperature probe cable connector
10	Pressure transmitter cable connector



Figure 9 Optidew 401 rear panel

## 2.4. Electrical Connections

### 2.4.1. Electrical Supply



**WARNING:**  
The instrument must be **GROUND**ED

The Optidew accepts a power supply of the following specification:

Voltage	100...240 V AC
Frequency	50...60 Hz
Power Consumption	30 VA max

**See Appendix A, Technical Specification, for full operating parameters.**

#### Optidew 501

The wall mount is supplied with a connector wired to a 2m cable. Only use an appropriately rated mains supply cord.

This power connector is wired as follows:

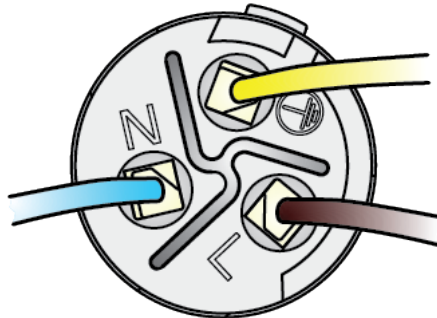

*Figure 10 Power Connector*

**NOTE:** The Optidew 501 is designed for continuous operation and therefore does not feature a power on/off switch. As soon as power is applied, the display (or DCC button on the transmitter version) will illuminate and the transmitter will initiate a DCC cycle.

Replacement power cables are available – contact your Michell representative.

#### Optidew 401

The Optidew 401 is supplied with a 2m IEC cable. The IEC socket is on the left-hand side of the instrument. There is an ON/OFF switch on the front panel. Only use an appropriately rated detachable mains supply cord.

## Fuse

This product is provided with an externally mounted fuse located next to the power connector. The fuse is rated at 5 x 20 mm medium acting: T 2.5 A H 250V.

## Equipment Ratings

This product is designed to be safe at least under the following conditions: between a temperature range of -40...+60 °C (-40...+148 °F), in maximum 80% relative humidity for temperatures up to +31 °C (+88 °F) decreasing linearly to 50 %rh at +50 °C (+122 °F). Overvoltage Category II. Pollution Degree 2. Altitudes up to 2000 m (6561.66 ft). Indoor use only but is IP65 rated.

**See Appendix A, Technical Specification, for full operating parameters.**

### 2.4.2. Analog and Digital Communications

**NOTE:** When using screened cable, the screen should only be connected to a ground point at either the Optidew installation side, or at the receiving equipment. Failure to observe this precaution can result in ground loops and equipment malfunction.

#### 2.4.2.1. Digital Communications

From left to right, the first four pins of this connector are used for RS485 communications.

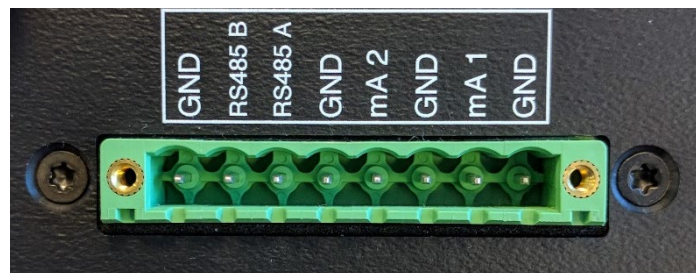

*Figure 11 RS485 & Analog output connector*

Pin Label	Description
<b>GND</b>	Ground
<b>RS485 B</b>	RS485 Data B
<b>RS485 A</b>	RS485 Data A
<b>GND</b>	Ground

The Optidew provides Modbus RTU over RS485 or USB (Bench Top only). An Ethernet module is optionally available for both instruments and provides Modbus TCP communication.

The Modbus register map can be found in Appendix B.

Application software is available and can be used to communicate with the instrument.

### 2.4.2.2. Current Outputs

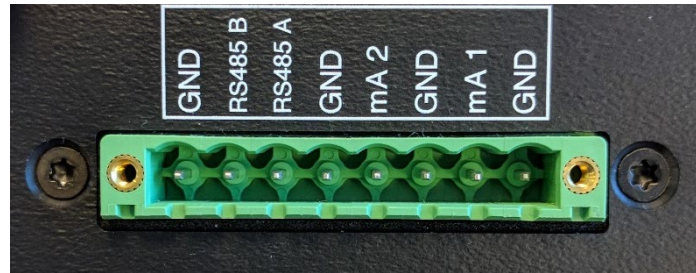

*Figure 12 Analog output connector*

Left to right, the last four pins on this connector are used for mA outputs.

See Section 3.2 for information on configuring the analog outputs

Pin Label	Description
<b>mA2</b>	Channel 2 Current Output
<b>GND</b>	Channel 2 Ground
<b>mA1</b>	Channel 1 Current Output
<b>GND</b>	Channel 1 Ground

### 2.4.2.3. Relay Contacts

There are two sets of relay contacts available via the output connector:

#### Process Alarm (Relay 1)

This relay changes state to indicate that the process variable has exceeded the alarm set point value. See Section 3.2 for details on how to configure the process alarm trip criteria. This alarm can also be used to give an early indication that the Optics require cleaning.

#### System Alarm (Relay 2)

This relay changes state to indicate a fault has occurred which requires operator intervention. See Section 4.6 for detailed information on faults.

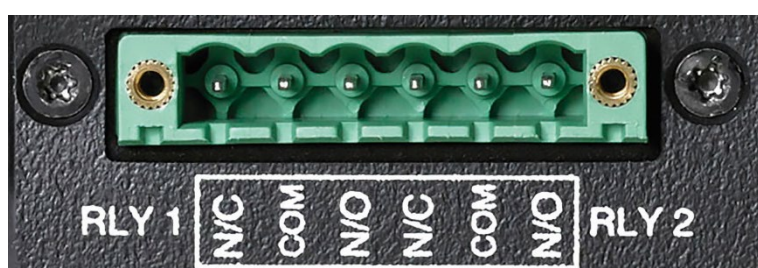

Figure 13 Relay contact connector

Pin Label (from left to right as shown)	Description
<b>N/C</b>	Relay 1 Normally Closed
<b>COM</b>	Relay 1 Common
<b>N/O</b>	Relay 1 Normally Open
<b>N/C</b>	Relay 2 Normally Closed
<b>COM</b>	Relay 2 Common
<b>N/O</b>	Relay 2 Normally Open

---

## 2.5. Sensor Installation

The dew-point sensor contains the optical system and the chilled mirror. It is fitted with a 12-pin M12 connector to allow easy and secure connection to the instrument using the supplied sensor cable.

The available options for sensor installation are:

- via a permanently installed sample port into which the remote sensor can be inserted or
- via a sensor block immediately attached to the sensor around which the sample circulates or
- in an ambient environment where the sample is diffusing through the sensor.

**NOTE: Ensure that the mirror surface is cleaned before installation. See Section 6 (Maintenance) for cleaning details.**

Connect the remote sensor cable to the sensor and to the instrument via the connector on the rear panel. The connector is a standard M12. Align the locating pin with the slot on the socket and press the connector into place. Rotate the outer collar of the cable-mounted part in a clockwise direction until finger tight.

If exchanging the sensor, refer to Section 6.2.

### 2.5.1. Environmental monitoring

If the instrument is to monitor the conditions in an environment, the sensor must be located in a representative position, i.e. not under an air conditioning vent.

A sensor wall mounting bracket is available to conveniently secure the sensor to a wall or panel.

**NOTE: It is recommended that the sensor is fitted with the porous aluminium guard to baffle it from flowing air currents.**

### 2.5.2. Monitoring a flowing sample

If the sensor is installed within a sealed gas system, it must be fixed securely without any possibility of leaks. Ensure that the sample flow across the sensor is correctly regulated.

The gas connections for the remote sensor are either via a permanently installed sample port into which the remote sensor can be inserted or via a sensor block immediately attached to the sensor around which the sample circulates. Gas sample entry into the sensor block is via couplings that can be installed into the provided  $\frac{1}{8}$ " NPT female threads. A bonded seal is provided to fill the connection between the sensor and the block.

Ensure that all connections to and from the sensor block are made with appropriate materials and fittings for moisture measurement. For guidance on suitable apparatus, see Section 4.3.

### 2.5.3. Environmental Chamber or Glovebox sensor mounting

If the sensor is to be positioned into a sealed but open environment (glove box, environmental chamber or area to be monitored) a female thread of M36 x 1.5-6 H is required to suitably thread onto the sensors male M36 x 1.5-6 g thread. The bonded seal provided will require a good surface finish (0.8 Ra) across a minimum sealing face of DIA 46.0 mm (1.81") to ensure leak-free operation up to the max operating pressure of the sensor (25 barg / 363 psig). The bonded seal will also require a strong hand tightening to ensure leak-free sealing of the two mating faces.

Always ensure you have tightened up with adequate torque to ensure leak-free sealing. Care should be taken when fitting the sensor to ensure the bonded seal remains centralized whilst threading the two mating M36 x 1.5 parts together. Also ensure that the sensor is suitably located in a position that will see a representative flow of the sample to be measured.

### 2.6. Temperature Probe Installation

The temperature probe is supplied pre-wired and simply requires fitting to the connector on the Optidew control unit prior to use.

Take into consideration how you will use the readings from your temperature probe before installing it. If the measurement will be used in combination with the dew point measurement to calculate %rh, then the temperature probe should be installed in a location which is most representative of the temperature of your environment or sample.

Be aware that when depressing the mirror temperature by more than 40 °C (104 °F), the Optidew dew-point sensor will generate a small amount of heat in the surrounding area. Try to situate the temperature probe upstream of the dew-point sensor and at least 150 mm (5.91") away.

Refer to Section 4.4.5 for more information on calculated parameters and which measured inputs are used to derive them.

---

### 2.6.1. Using Temperature Probes with a chamber port adapter

The following Michell Instruments and Rotronic products are available to order with a port adaptor which fits the Laboratory/High Temperature Probe only:

- HygroCal100
- S904
- OptiCal
- Hygrogen 2

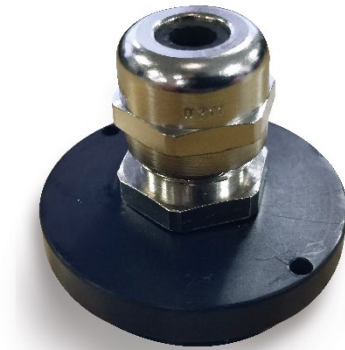

*Figure 14 Temperature Probe Adapter*

### 2.7. Pressure Transmitter Installation

Pressure transmitters are available for the Optidew in several ranges. Any 4...20 mA pressure transmitter can be wired into the Optidew control unit via the 4-pin M12 connector. Michell can supply a pressure transmitter with the Optidew, which is installed via a 1/8" NPT male thread.

The pressure source should be installed with consideration to the calculated values which will be used. For example, if the dew-point sensor is installed at process pressure, then the pressure sensor should be installed into the sample block. However, if the dew-point sensor is installed at a different pressure to the process, the pressure sensor should be installed in a different location which is at full process pressure. For information on the pressure compensation feature refer to Section 4.4.5.

### 3. USER INTERFACE

There are two different local user interfaces available. The analyzer features a 5.7" color touch screen display and the transmitter has a button with multicolor LED indicator.

The application software gives the user access to all functionality available through the local user interface. The Optidew offers three interfaces to connect to a PC or network:

- RS485
- USB (only available on Optidew 401)
- Ethernet (Optional)

#### 3.1. Main Display

When the instrument is switched on, an 'initialising' overlay will be shown while the menu system loads.

After the menu system has loaded, the Main Screen will show.

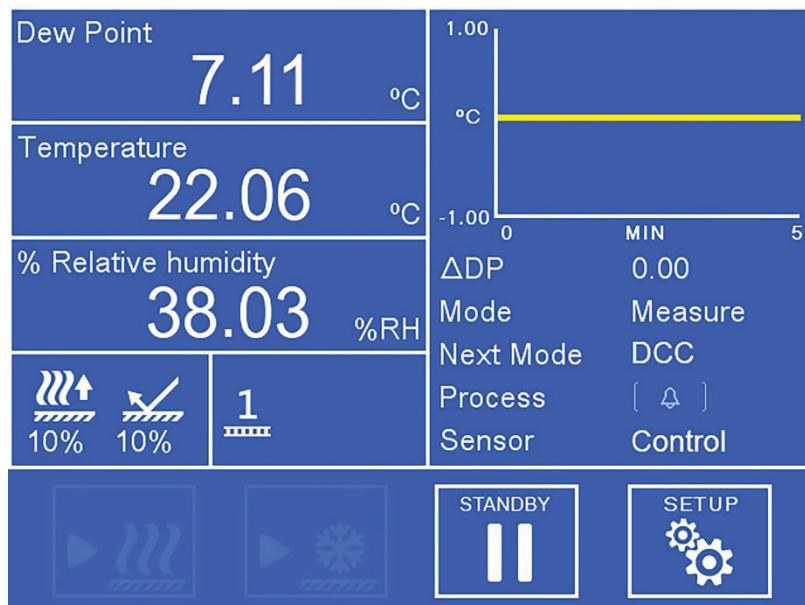

Figure 15 Main Screen

##### 3.1.1. Full Screen Mode

Any of the readouts can be shown in full screen mode by touching and holding the readout.

### 3.1.2. Main Screen

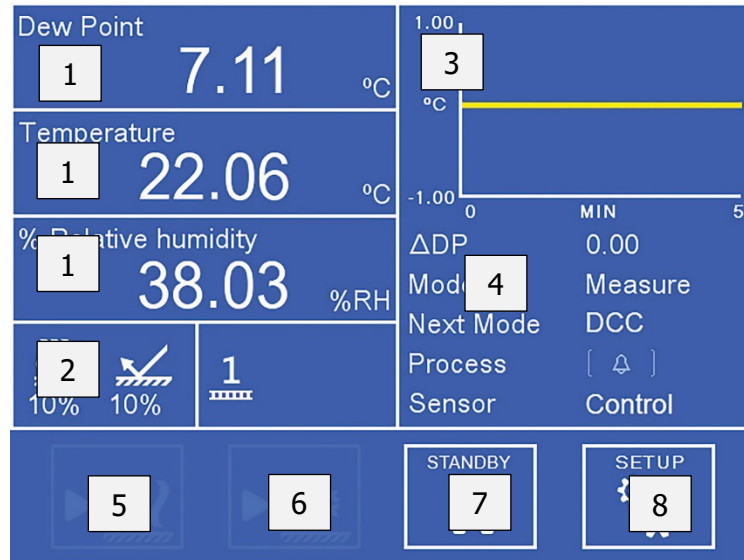

Figure 16 Main Screen layout

No.	Name	Description
1	Customizable Readouts	Display measured and calculated parameters. See Section 3.1.3 for additional information
2	Sensor Status Display	Displays both thermo-electric cooler (TEC) drive and optical signal condition. Also indicates whether TEC is 1 or 2 stage. See Section 3.1.7 for additional information
3	Trend Graph	Plots measured dew point over time. Time base can be changed in display settings. Touch the readout once to enter full screen mode.
4	Operational Status Display	See Section 3.1.6 for a detailed description of this area.
5	DCC On/Off	Initiates or cancels a DCC. See Section 4.4.1 for an explanation of the DCC function. See Section 3.2 for DCC setup parameters.
6	Max Cool On/Off	Initiates or cancels a Max Cool. See Section 4.4.2 for an explanation of the Max Cool function.
7	Standby/Operate	Toggles between Measure and Standby modes. When switching to Measure mode a DCC cycle will be initiated.
8	Setup	Access the Setup menu. See Section 3.1.5 for information on the menu structure and options.

### 3.1.3. Customizable Readouts

The three readouts on the Main Screen can be configured by the User to show any of the following parameters:

- Dew Point
- Temperature
- Pressure
- % Relative Humidity
- g/m<sup>3</sup>
- g/kg
- ppmV
- %Vol
- Twb
- wvp (water vapor pressure)
- Dew Point (pressure corrected)

To change a parameter:

1. Touch the readout once to enable parameter selection
2. Touch the left or right arrows to select the parameter to be displayed
3. Touch the centre of the readout to confirm selection

### 3.1.4. Locking the analyzer

From firmware version 1.0.1 onwards it is possible to lock the analyzer so unauthorized users cannot change any settings. Go to the SETUP page and in the bottom left-hand corner there is a padlock icon on that is greyed out. Pressing it will bring up the passcode entry screen where you will need to enter 5491. The padlock icon will become solid to show it is now activated.



After five minutes, this function will lock the analyzer (you will need to return to the main screen). To unlock the screen, you must enter 5491.

It is possible to deactivate the function before it is triggered or after activation by simply pressing the solid padlock item in the Settings Menu.

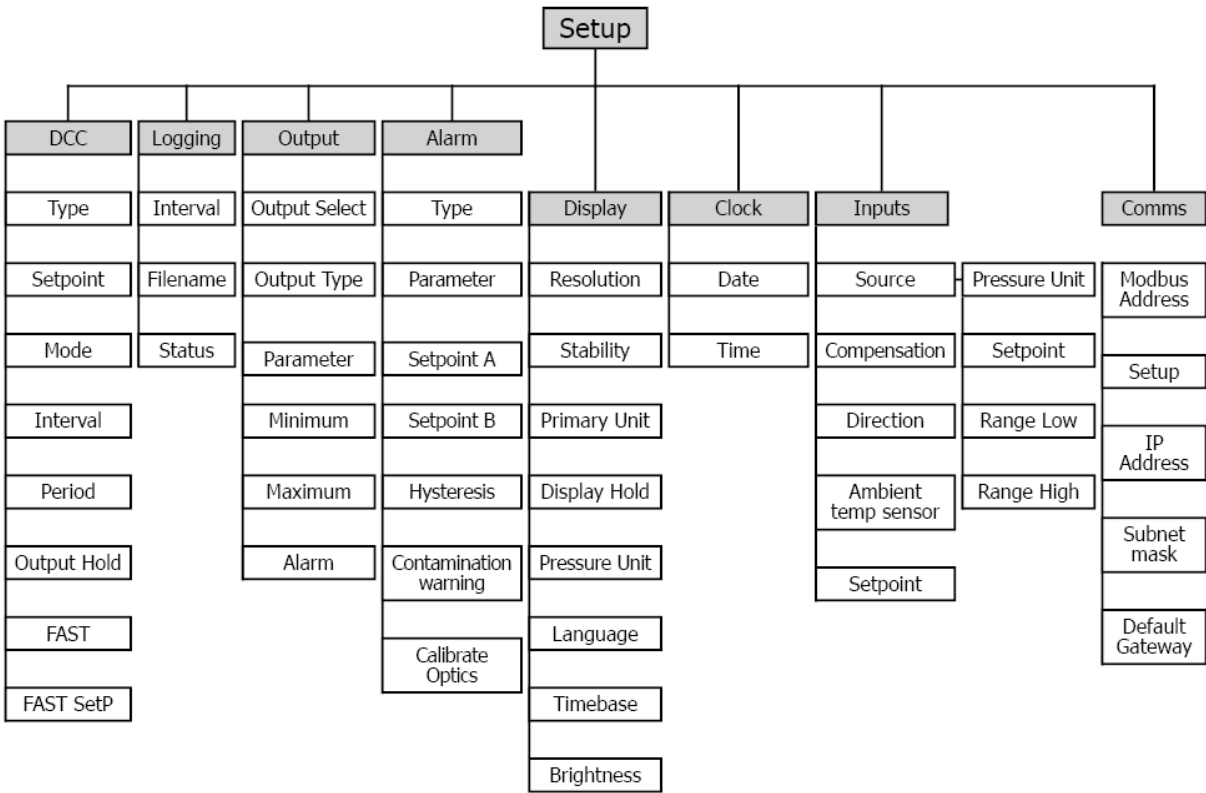
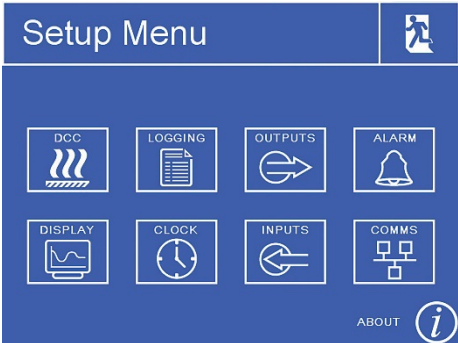



3.1.5. Menu Structure



### 3.1.6. Operational Status Display

<p><b>ΔDP</b></p>	<p>Shows total change in measured dew point over the time base of the trend graph</p>
<p><b>Mode</b></p>	<p>Shows current operation mode:</p>
<p><b>Next Mode</b></p>	<p>Measure, Standby, DCC, Max Cool, Data Hold</p>
<p><b>Process</b></p>	<p>Status of process alarms</p> <p>  Alarm is active   Alarm is inactive         </p> <p>For further information on alarm configuration see Sections 3.2 and 5.</p>
<p><b>Sensor</b></p>	<p>Indicates whether the sensor has established a condensate formation, or if the system is in a transient condition: Heating, Cooling, Control.</p>

**3.1.7. Sensor Status Display**

<p><b>TEC Drive</b></p>		<p>Indicates whether the sensor is heating or cooling the mirror:</p> <p>Also indicates the power level applied as a percentage of total possible.</p>
<p><b>Optical Signal</b></p>		<p>Indicates the reflectivity of the mirror, and whether this is clean or has a condensate formation.</p> <p>The target is 100% signal level, which indicates the optimal film thickness has been achieved. 0% indicates that the mirror is free of condensate.</p> <p>For further information see Section 4.2.1.</p>
<p><b>Connected sensor</b></p>		<p>Shows the sensor type that the control unit is configured for.</p> <p>To connect a 1-Stage sensor to a control unit configured for 2-Stage or vice-versa, you must first use the PC application software to enter the sensor configuration code found on the calibration certificate.</p> <p>Refer to Section 6.2 (Exchanging Sensors).</p>
<p><b>Logging</b></p>		<p>When shown, the Optidew is currently logging data to SD. See Section 4.4.6 for further information.</p>
<p><b>Pressure Compensation</b></p>		<p>Displayed when pressure compensation is active. See Section 4.4.5 for further information.</p>

### 3.2. Setup Menus

#### 3.2.1. DCC

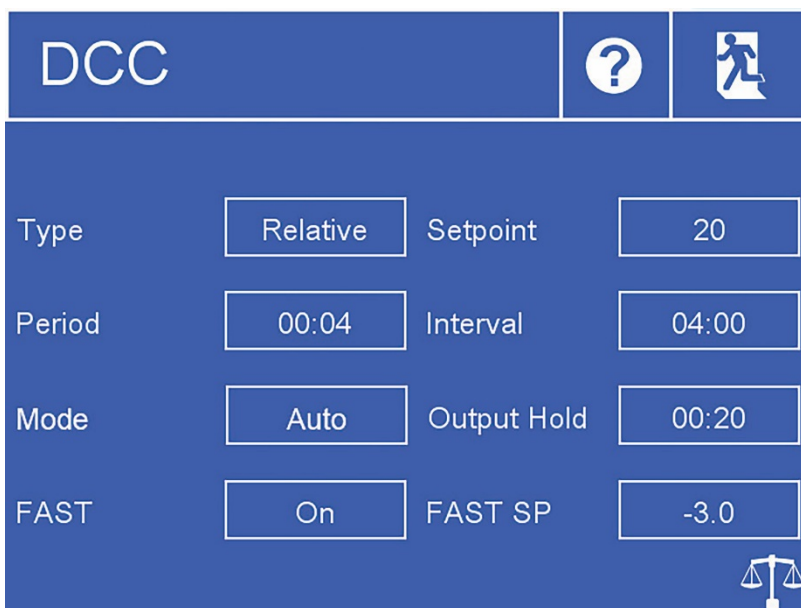

Figure 17 DCC Menu

<b>Type</b>	DCC heating temperature can either be relative to last measured dew point or an absolute temperature. Actual temperature or $\Delta$ is defined by 'Setpoint'. <b>Available input:</b> Relative, Absolute
<b>Setpoint</b>	Mirror heating temperature during DCC, either absolute or relative to last measured dew point. See 'Type' option above. <b>Available input:</b> 1...120 °C
<b>Mode</b>	DCCs can either be triggered automatically at every Interval, or they can be manually triggered only. <b>Available input:</b> Manual, Auto
<b>Interval</b>	Time between automatic DCCs <b>Input format:</b> hh:mm <b>Limits:</b> 01:00...99:00
<b>Period</b>	Duration of a DCC <b>Input format:</b> hh:mm <b>Limits:</b> 00:01...00:59
<b>Output hold</b>	Minimum time to hold analog outputs after finishing a DCC <b>Input format:</b> hh:mm <b>Limits:</b> 00:04...00:59

---

---

<b>FAST</b>	Turns frost assurance on or off. See Section 4.4.3 for further information <b>Available input:</b> On, Off
<b>FAST SetP</b>	Passing this mirror temperature will trigger the frost assurance function without a DCC <b>Available input:</b> -28...-2 °C

### 3.2.2. Logging

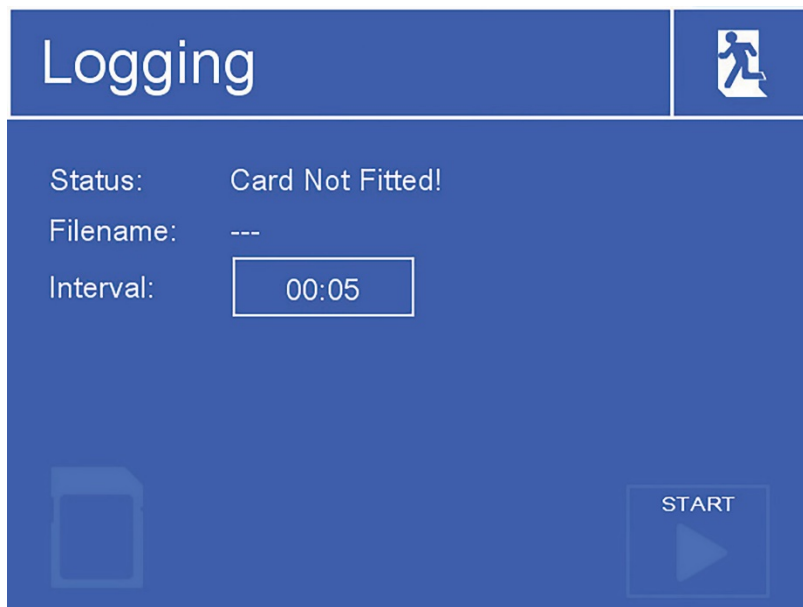







Figure 18 Logging Screen

<b>Interval</b>	Changes the interval at which data is recorded <b>Input format:</b> mm:ss – <b>Limits:</b> 00:05...10:00	
<b>SD status indicator:</b>	Indicates status of inserted SD card:	
		No SD Card inserted
		Ready to log
		Initialising card
		Error occurred
		SD Card is write protected
		Logging
<b>Start/Stop</b>	Begins a new log (file name is generated automatically) or ends a log in progress.	

3.2.3. Outputs

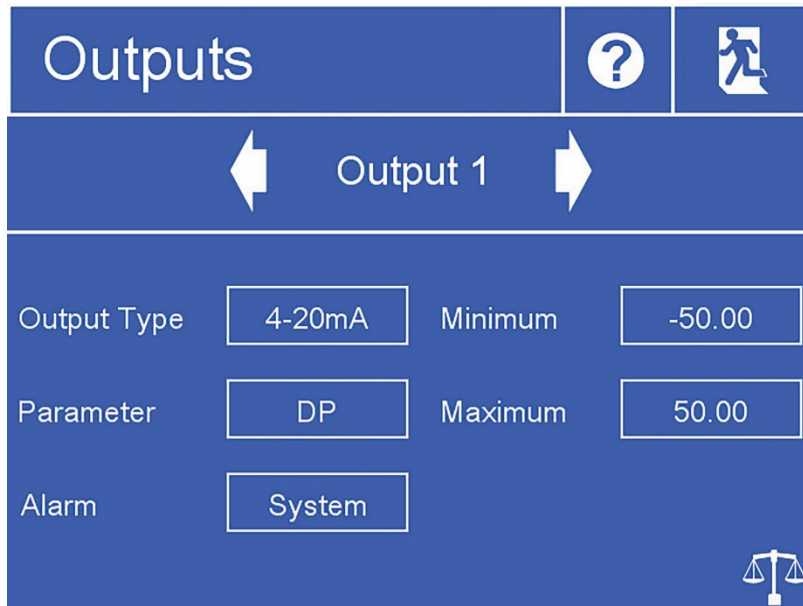

Figure 19 Outputs Screen

<b>Output selector arrows</b>	Selects the output to be adjusted
<b>Output Type</b>	Determines the mA output range <b>Available input:</b> 0...20 mA, 4...20 mA
<b>Parameter</b>	Assigns the chosen calculated or measured parameter to this output channel <b>Available input:</b> DP, Temperature, Pressure, %rh, wvp, g/m <sup>3</sup> , g/kg, ppm <sub>v</sub> , Wet Bulb
<b>Alarm</b>	If the selected alarm is tripped, then this output will be forced to Namur alarm level (20.6 mA). <b>Available input:</b> None, System, Process, Both
<b>Minimum</b>	The minimum output range for the selected parameter <b>Available input:</b> Dependent on parameter
<b>Maximum</b>	The maximum output range for the selected parameter <b>Available input:</b> Dependent on parameter

### 3.2.4. Alarm

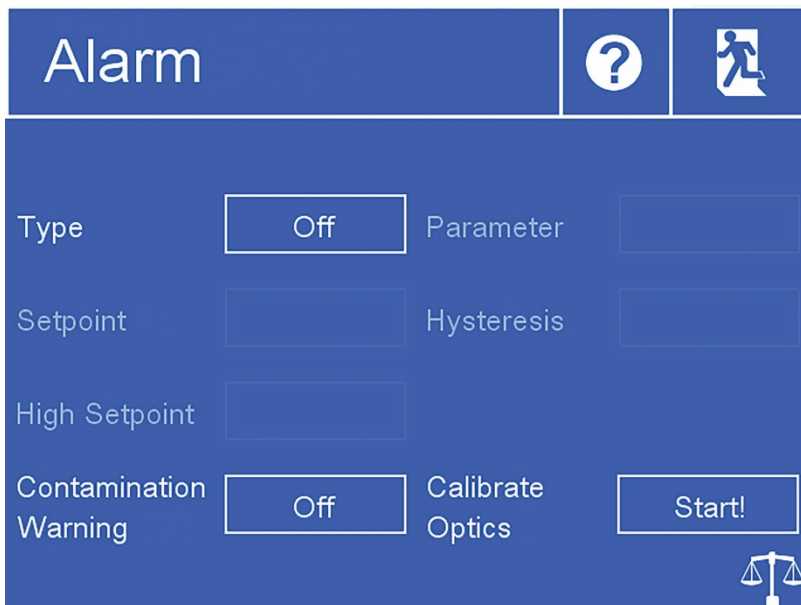

Figure 20 Alarm Screen

<b>Type</b>	Sets the trip criteria for the process alarm <b>Available input:</b> Over, Under, In. Band, Out. Band, Off
<b>Parameter</b>	Sets the parameter associated with the process alarm <b>Available input:</b> DP, Temperature, Pressure, %rh, wvp, g/m <sup>3</sup> , g/kg, ppm <sub>v</sub> , ppm <sub>W</sub> , Wet Bulb
<b>Setpoint</b>	Sets the trip point for Over or Under alarm types <b>Available input:</b> Dependent on parameter
<b>Low Setpoint</b>	Sets the low trip point for Band alarm types <b>Available input:</b> Dependent on parameter
<b>High Setpoint</b>	Sets the high trip point for Band alarm types <b>Available input:</b> Dependent on parameter
<b>Hysteresis</b>	Sets the deviation from trip point before the alarm deactivates <b>Available input:</b> Dependent on parameter
<b>Contamination Warning</b>	Sets whether an Optics Warning trips the process alarm. Refer to Section 5 for information about the optics warning. <b>Available input:</b> On, Off
<b>Calibrate Optics</b>	It is necessary to run this function whenever the mirror is cleaned, or if a different dew-point sensor is installed. Following this, a DCC will begin.

3.2.5. Display

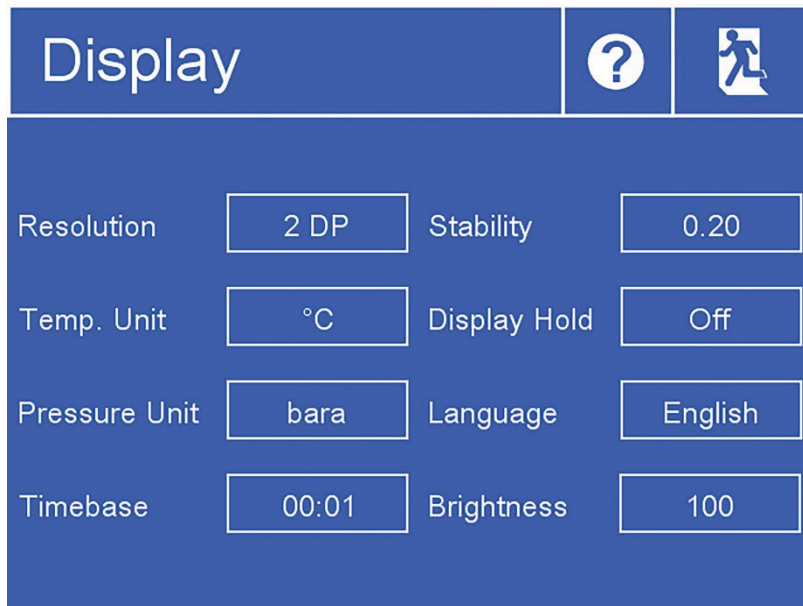

Figure 21 Display Screen

<b>Resolution</b>	Changes the number of decimal places for all displayed parameters <b>Available input:</b> 1 DP, 2 DP
<b>Temperature Unit</b>	Measurement unit for temperature values <b>Available input:</b> °C, °F
<b>Pressure Unit</b>	Measurement unit for pressure values <b>Available input:</b> kPa, psig, psia, barg, bara
<b>Timebase</b>	X axis span for trend graph on main screen <b>Input format:</b> hh:mm <b>Limits:</b> 00:01...10:00
<b>Stability</b>	Determines a stable measurement following DCC, which is conditional to release Data Hold. Entered value is $\Delta$ DP over 30s. <b>Available input:</b> 0.2...20
<b>Display Hold</b>	When enabled, values on display are also held during Data Hold <b>Available input:</b> Off, On
<b>Language</b>	Sets User Interface language <b>Available input:</b> English, Deutsch, Español, Français, Italiano, Português, USA, Russian, Chinese, Japanese
<b>Brightness</b>	Display backlight control <b>Available input:</b> 0...100%

3.2.6. Clock

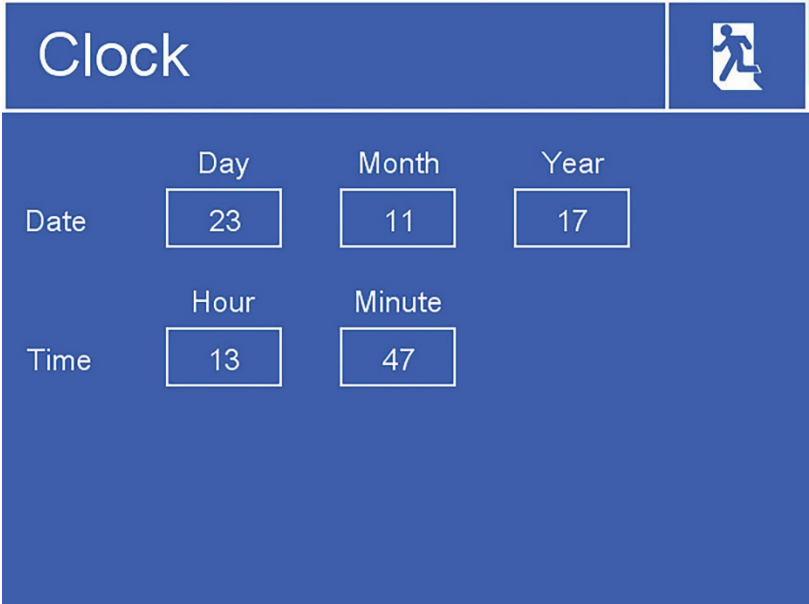

Figure 22 Clock Screen

<b>Date</b>	Current date
<b>Time</b>	Current time

3.2.7. Inputs

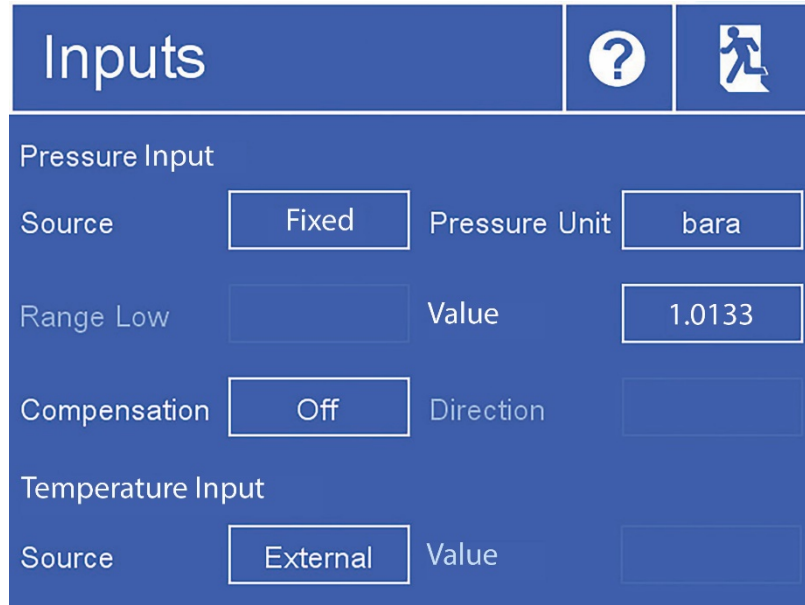

Figure 23 Inputs Screen

<b>Source (Pressure Input)</b>	Changes between pressure input from external 4...20 mA transmitter or a fixed value <b>Available input:</b> Fixed, External
<b>Pressure Unit</b>	Measurement unit for pressure inputs <b>Available input:</b> kPa, psig, psia, barg, bara
<b>Value (If 'Fixed' selected)</b>	Sets pressure used for internal calculations
<b>Range Low (If 'External' selected)</b>	Sets the low range of the connected pressure transmitter
<b>Range High (If 'External' selected)</b>	Sets the high range of the connected pressure transmitter.
<b>Compensation</b>	Recalculate dew point based on pressure input <b>Available input:</b> Off, On
<b>Direction (If 'Compensation' On)</b>	Select 'From Atmos' if dew-point sensor is at atmospheric pressure. Select 'To Atmos' if dew-point sensor is at entered fixed pressure or pressure measured by transducer.
<b>Source (Temperature Input)</b>	Changes between temperature input from external PT100 or a fixed value. <b>Available input:</b> Fixed, External
<b>Value (If 'Fixed' selected)</b>	Sets temperature used for internal calculations

### 3.2.8. Comms Screen

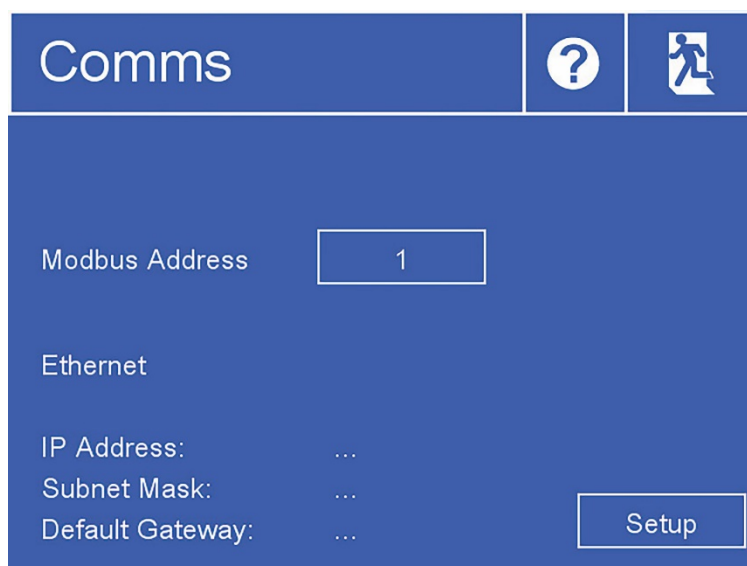

Figure 24 Comms Screen

<b>Modbus Address</b>	Sets the Modbus slave address for this Optidew
<b>Setup</b>	Access the TCP/IP Network Settings page

### 3.2.9. Network Settings

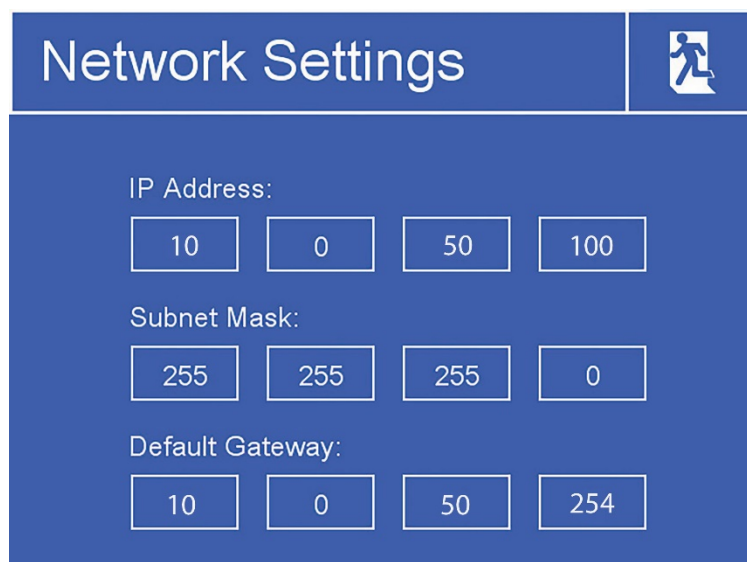

Figure 25 Network Settings Screen

<b>IP Address</b>	IP address of the instrument (default 10.0.50.100)
<b>Subnet Mask</b>	Determines network subnet address (default 255.255.255.0)
<b>Default Gateway</b>	Default gateway address (default 10.0.50.254)

### 3.3. Optidew 501 Transmitter without display

The Optidew 501 can also be ordered as a blind transmitter without display. This variant instead comes with a single multi-function button with integrated colored LED status indicator.

The indicator changes color and pulse rate depending on the instrument status.

Meaning	LED Color
Initialisation	White
DCC	Blue
DCC Plus	Flashing Blue (Fast)
Optics balance	Flashing Blue
Searching for dew point	Flashing Green
Searching for dew point – Optics contaminated	Flashing Magenta
Optics contaminated & Process alarm off	Magenta
Optics contaminated & Process alarm on	Flashing Red/Magenta
Measuring	Green
Measuring & Process alarm on	Flashing Red
MaxCool	Blue
Standby	Flashing Yellow
Standby – Optics contaminated	Flashing Yellow/Magenta
System Fault Red	Red

Pressing the button has two different effects, depending on the mode that the instrument is in:

In DCC or DCC Plus mode – pressing the button returns to standby

In all other modes – pressing the button initiates manual DCC

#### 3.3.1. Optics Calibration

After power is applied the LED indicator on the front of the instrument will turn white for the first 5 seconds. Pressing the button during this phase will initiate an optics calibration. The indicator will flash indicating the button-press has been registered.

## 4. OPERATION

### 4.1. Operating Cycle

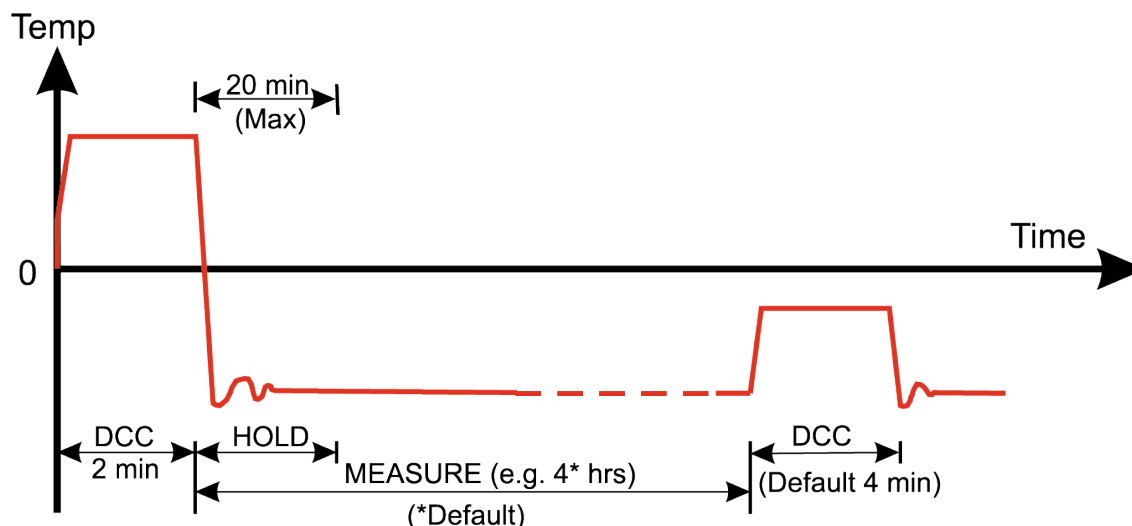

Figure 26 Typical Operating Cycle

At initial switch-on, the instrument enters a DCC cycle for 2 minutes. During this time the mirror is heated above the prevailing dew point to ensure that all condensate is driven off the surface of the mirror. The degree of heating is determined by the configuration of the 'Type' and 'Setpoint' parameters in the DCC menu (see Section 3.2 for further information).

The mirror is maintained at this temperature for the DCC period (default 4 minutes) or 2 minutes on switch-on. During the DCC process, Data Hold fixes the analog outputs at the same value(s) as before DCC commenced. Data Hold typically lasts 4 minutes from the end of a DCC cycle, or until the instrument has reached the dew point. This procedure is in place to prevent any system which is connected to the outputs from receiving a 'false' reading.

After the DCC period has finished, the measurement period commences, during which the control system decreases the mirror temperature until it reaches the dew point. The sensor will take a short amount of time to form a film of condensate and control on the dew point. The length of this stabilization time depends upon the dew-point temperature. When the measurement is stable or tracking very slow changes in dew point, the Sensor indicator in the Operational Status display will indicate 'Control'. Note that at dry dew points (below around  $-20\text{ }^{\circ}\text{C}/-4\text{ }^{\circ}\text{F}$ ) the sensor may display 'Control' when the mirror temperature is still slowly oscillating, always use the trend graph on the display as a secondary indication.

The end of a DCC cycle re-sets the interval counter, meaning that another DCC will start (by default) after 4 hours have elapsed. Once the measurement is stable, Data Hold will release, and the analog outputs will resume their normal operation. At this point the Status area of the Operational Status display will change to 'Measure'.

## 4.2. Operating Guide

### 4.2.1. Description

Once the Optidew has been powered on and has carried out its' initial DCC, it will attempt to find the dew point. In order to measure the dew point a Chilled Mirror hygrometer must control a thin film of condensed water or ice on the mirror.

To initially form the condensate layer the mirror must be cooled past the actual dew or frost point. The control system will then gradually heat the mirror to reduce the thickness of this condensate layer. It typically takes several heating/cooling cycles until the instrument has achieved the optimal film thickness where evaporation and condensation are occurring in equilibrium. This is the true dew/frost point of the sample.

After finding the true dew point, the control system will continue to maintain the film thickness at a constant level. Any decrease in actual sample dew point will cause evaporation from the condensate film to increase – reducing its thickness and causing the control system to cool the mirror to compensate. Likewise, if the dew point increases then condensation on the mirror will increase, and the control system will heat to compensate.

In extreme cases where the dew point decreases very abruptly, then the condensate will be completely evaporated from the mirror. In these scenarios the system will 'search' for the dew point again by cooling, resulting in cooling past the dew point as described above. A similar situation occurs when the dew point increases abruptly, however the condensate film can be lost here by the control system heating to compensate and exceeding the new dew point.

### 4.2.2. Operating Practice

There are two basic methods of measuring with the Optidew:

In-situ measurements are made by placing the sensor(s) inside the environment to be measured.

Extractive measurements are made by installing the sensor into a block within a sample handling system, and flowing the sample outside of the environment to be measured through this system

Extractive measurements are recommended when the conditions in the environment to be measured are not conducive to making reliable measurements with the product. Examples of such conditional limitations are:

- Excessive flow rate
- Presence of particulates matter
- Presence of entrained liquids
- Excessive sample temperature
- Dew point is beyond depression capability at sample temperature

The basic considerations for each measurement type are as follows:

## **In Situ:**

1. **Dew-Point Sensor position** – Will the sensor see an area of the environment that is representative of what you want to measure? For example; you are looking to measure the Relative Humidity of a room which is controlled by an HVAC vent at either end (see Figure 27) you will get very different readings depending on whether the sensor is positioned at point A, point B or point C. Point C provides the most representative sampling point given that it won't be disturbed by the vent or the door.

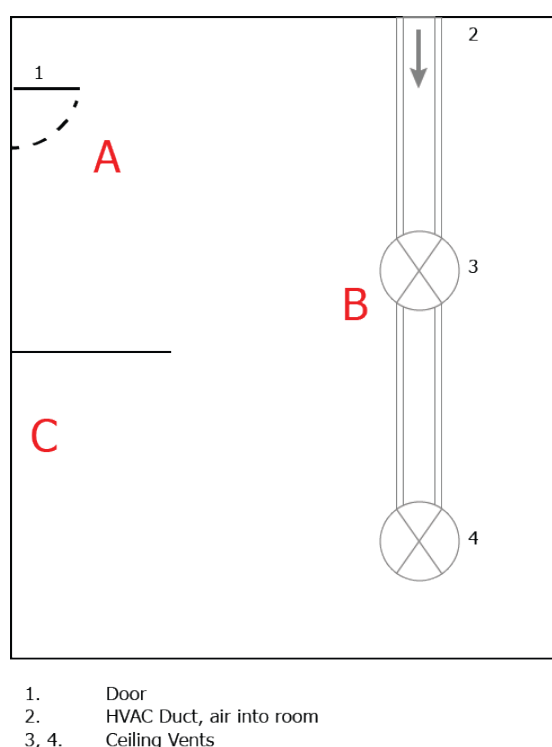

*Figure 27 Room Measurement Example*

2. **Gas speed** – If you are planning on installing the sensor in a duct, consider how fast the sample gas is moving through it. Excessive flow speed will cause displacement of the condensate layer on the mirror, leading to unstable measurement. If this is the case, then a guard fitted over the sensor can mitigate the effects of excessive gas speed by dissipating the sample throughout it's surface area. An appropriate guard can be purchased from Michell Instruments, contact your local representative.

3. **Particulates** – Particulates passing over the sensor can build up on the mirror over time. This can cause a loss of mirror reflectivity. DCC will compensate for this by taking into account anything on the surface of the mirror when resetting the optical condition, however if the problem becomes too severe, the 'mirror contamination warning' symbol will be displayed in the Sensor Status display.



*Figure 28 Mirror Contamination Warning Symbol*

4. **Sample temperature** – Consider the difference between the sample temperature and the dew-point temperature. Make sure that the sensor you are using has the cooling capability to make the measurement (see Section 4.5 for further information). If the sensor does not have the necessary cooling capability, then you should consider an extractive system so the sample can be cooled prior to measurement.
5. **Sample pressure** – If you are interested in readings in terms of ppm<sub>v</sub> or g/m<sup>3</sup>, ensure that the sensor is positioned in an environment of known pressure. You can then either enter this pressure into the Optidew via the 'Inputs' screen (see Section 3.2) or connect a pressure sensor directly to the point of measurement (see Section 2.6).

### **Extractive**

If the sensor will be mounted into a sample conditioning system, then the above points are still of relevance, but the following should also be considered:

1. **Extraction point** – Make sure that the chosen extraction point is representative of the process, i.e. that the sample of interest is flowing past the extraction point, and it is not being pulled from a dead volume.
2. **Enclosure and sample line heating** – If the sample has a dew point greater than ambient temperature, then all components upstream of the sensor will need to be heated to at least 10 °C (18 °F) above the sample dew point to ensure the water remains in vapor phase.
3. **Sample block flow path** – The sensor block must be configured with gas inlet and outlets installed in the side ports. The top is either blanked or used to install a pressure transmitter.

**If replacing an old Optidew installation then be aware that using the old sensor block will result in poor response speed at low dew points, as it does not allow enough flow across the mirror.**

### 4.3. Good Measurement Practice

#### 4.3.1. Sampling Hints

Ensuring reliable and accurate moisture measurements requires the correct sampling techniques, and a basic understanding of how water vapor behaves. This section aims to explain the common mistakes and how to avoid them.

#### Sampling Materials – Permeation and Diffusion

All materials are permeable to water vapor since water molecules are extremely small compared to the structure of solids, even including the crystalline structure of metals. The graph below demonstrates this effect by showing the increase in dew point temperature seen when passing very dry gas through tubing of different materials, where the exterior of the tubing is in the ambient environment.

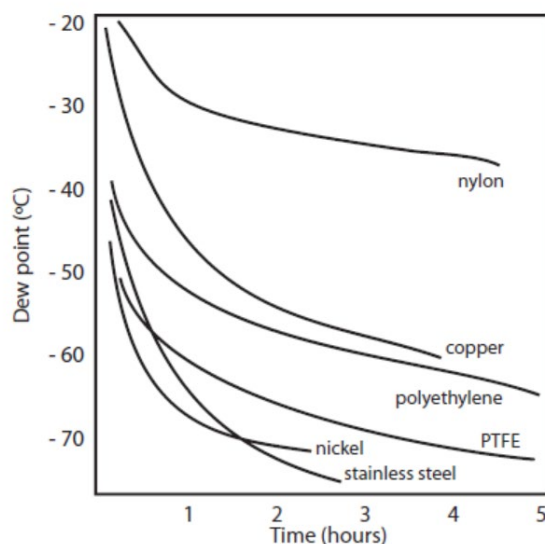

*Figure 29 Material Permeability Comparison*

What this demonstrates is the dramatic effect that different tubing materials have on the humidity levels of a gas passed through them. Many materials contain moisture as part of their structure and when these are used as tubing for a dry gas the gas will absorb some of the moisture. Always avoid using organic materials (e.g. rubber), materials containing salts and anything which has small pores which can easily trap moisture (e.g. nylon).

As well as trapping moisture, porous sampling materials will also allow moisture vapor to ingress into the sample line from outside. This effect is called diffusion and occurs when the partial water vapor pressure exerted on the outside of a sample tube is higher than on the inside. Remember that water molecules are very small so in this case the term 'porous' applies to materials that would be considered impermeable in an everyday sense – such as polyethylene or PTFE. Stainless steel and other metals can be considered as practically impermeable and it is surface finish of pipework that becomes the dominant factor. Electropolished stainless steel gives the best results over the shortest time period.

Take into consideration the gas you are measuring, and then choose materials appropriate to the results you need. The effects of diffusion or moisture trapped in materials are more significant when measuring very dry gases than when measuring a sample with a high level of humidity.

### Temperature and Pressure effects

As the temperature or pressure of the environment fluctuates, water molecules are adsorbed and desorbed from the internal surfaces of the sample tubing, causing small fluctuations in the measured dew point.

*Adsorption* is the adhesion of atoms, ions, or molecules from a gas, liquid, or dissolved solid to the surface of a material, creating a film. The rate of adsorption is increased at higher pressures and lower temperatures.

*Desorption* is the release of a substance from or through the surface of a material. In constant environmental conditions, an adsorbed substance will remain on a surface almost indefinitely. However, as the temperature rises so does the likelihood of desorption occurring.

Ensuring the temperature of the sampling components is kept at consistent levels is important to prevent temperature fluctuation (i.e. through diurnal changes) continually varying the rates of adsorption and desorption. This effect will manifest through a measured value which increases during the day (as desorption peaks), then decreasing at night as more moisture is adsorbed into the sampling equipment.

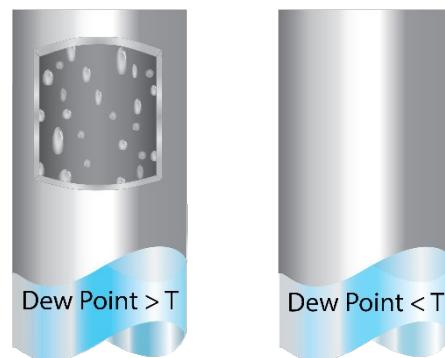

*Figure 30 Condensation in Sample Tubing*

*If temperatures drop below the sample dew point, water may condense in sample tubing and affect the accuracy of measurements.*

Maintaining the temperature of the sample system tubing above the dew point of the sample is vital to prevent condensation. Any condensation invalidates the sampling process as it reduces the water vapor content of the gas being measured. Condensed liquid can also alter the humidity elsewhere by dripping or running to other locations where it may re-evaporate.

Although ambient pressure does not change drastically in a single location, the gas sample pressure does need to be kept constant to avoid inconsistencies introduced by adsorption or desorption. The integrity of all connections is also an important consideration, especially when sampling low dew points at an elevated pressure. If a small leak occurs in a high-pressure line, gas will leak out, however, vortices at the leak point and a negative vapor pressure differential will also allow water vapor to contaminate the flow.

Theoretically flow rate has no direct effect on the measured moisture content, but in practice it can have unanticipated effects on response speed and accuracy. An inadequate flow rate may:

- Accentuate adsorption and desorption effects on the gas passing through the sampling system.
- Allow pockets of wet gas to remain undisturbed in a complex sampling system, which will then gradually be released into the sample flow.
- Increase the chance of contamination from back diffusion. Ambient air that is wetter than the sample can flow from the exhaust back into the system. A longer exhaust tube can help alleviate this problem.
- Slow the response of the sensor to changes in moisture content.

An excessively high flow rate can:

- Introduce back pressure, causing slower response times and unpredictable changes in dew point
- Result in a reduction in depression capabilities in chilled mirror instruments by having a cooling effect on the mirror. This is most apparent with gases that have a high thermal conductivity such as hydrogen and helium.

### **System design for fastest response times**

The more complicated the sample system, the more areas there are for trapped moisture to hide. The key pitfalls to look out for here are the length of the sample tubing and dead volumes.

The sample point should always be as close as possible to the critical measurement point to obtain a truly representative measurement. The length of the sample line to the sensor or instrument should be as short as possible. Interconnection points and valves trap moisture, so using the simplest sampling arrangement possible will reduce the time it takes for the sample system to dry out when purged with dry gas.

Over a long tubing run, water will inevitably migrate into any line, and the effects of adsorption and desorption will become more apparent.

Dead volumes (areas which are not in a direct flow path) in sample lines, hold onto water molecules which are slowly released into the passing gas. This results in increased purge and response times, and wetter than expected readings. Hygroscopic materials in filters, valves (e.g. rubber from pressure regulators) or any other parts of the system can also trap moisture. Plan your sampling system to ensure that the sample tap point and the measurement point are as close as possible to avoid long runs of tubing and dead volumes.

### **Filtration**

All trace moisture measurement instruments and sensors are by their nature sensitive devices. Many processes contain dust, dirt or liquid droplets. Particulate filters are used for removing dirt, rust, scale and any other solids that may be in a sample stream. For protection against liquids, a coalescing or membrane filter should be used. The membrane provides

protection from liquid droplets and can even stop flow to the analyzer completely when a large slug of liquid is encountered, saving the sensor from potentially irreparable damage.

### 4.3.2. First Time Operation

Before using the instrument, please read through the Installation, Operation and Maintenance sections of this manual. This instruction assumes that all recommendations within these sections have been followed, and that the control unit and sensors are physically installed and all electrical connections complete.

- Ensure that all sample connections are in good condition, of appropriate materials and are leak-tight
- Clean the mirror according to the instructions in Section 6.1
- Control the flow rate to within 0.1...2 NI/min (1 l/min optimal)
- Power on the instrument

**NOTE: if the dew point sensor has been swapped, refer to Section 5.2**

## 4.4. Operational Functions

### 4.4.1. DCC Function

Dynamic Contamination Control (DCC) is a system designed to compensate for the loss of measurement accuracy which results from mirror surface contamination.

During the DCC process the mirror is heated to a default temperature of 20 °C (36 °F) above the dew point to remove the condensation which has formed during measurement.

The surface finish of this mirror, with the contamination which remains, is used by the optics as a reference point for further measurements. This removes the effect of contamination on accuracy.

After switch-on, the mirror is assumed to be clean, therefore the instrument will only run a DCC for 2 minutes to quickly establish a clean mirror reference point. By default, every subsequent DCC is 4 minutes in duration and will automatically occur every 4 hours.

At certain times it may be desirable to disable the DCC function in order to prevent it from interrupting a measurement cycle, e.g. during a calibration run. This is achieved by setting 'Mode' to 'Manual' in the DCC menu. See Section 3.2 for further details.

A manual DCC can be initiated or cancelled by touching the DCC button on the Main Screen. The DCC button is context sensitive, i.e. if DCC is on, the Main Screen shows DCC OFF as being selectable. Similarly, if DCC is off, DCC ON is shown.

It is possible to change the parameters relating to the DCC cycle on the DCC Setup Screen, refer to Section 3.2.

## DCC Plus

DCC Plus is a feature designed to further control the build-up of contaminants on the mirror surface without physical intervention from the operator. The function operates immediately prior to either a scheduled automatic DCC or a manual DCC, by cooling the mirror for a few seconds before heating it.

This cooling causes additional condensation on the mirror, which dissolves water-soluble matter, and dislodges non water-soluble matter. When the surface is then heated and the water evaporated, the contamination will cluster together leaving areas of clean mirror between, which has less overall impact on the optics.

### 4.4.2. MAXCOOL Function

The MAXCOOL function overrides the dew point control loop and applies maximum cooling drive to the Peltier heat pump. It can be used to determine:

- What temperature the mirror can be driven down to with reference to the sensor body.
- Whether or not the instrument is controlling at the dew point and whether it is able to reach it. This situation could, for instance, arise when attempting to measure very low dew points where, possibly due to a high ambient temperature, the Peltier heat pump is unable to depress the temperature far enough to reach the dew point.
- Whether the instrument is controlling by switching MAXCOOL on for a short period and then switching back to MEASURE. This will depress the mirror temperature briefly and when it is switched back to MEASURE the control loop should be able to stabilize the mirror temperature at the dew point again.

The MAXCOOL function can be turned on by touching the MAXCOOL button on the Main Screen.

### 4.4.3. Frost Assurance Technology (FAST)

In carefully controlled laboratory conditions, super-cooled water can exist in temperatures as low as  $-48\text{ }^{\circ}\text{C}$  ( $-54.4\text{ }^{\circ}\text{F}$ ). However, when using a chilled mirror instrument it only occurs on the mirror at temperatures down to around  $-30\text{ }^{\circ}\text{C}$  ( $-22\text{ }^{\circ}\text{F}$ ).

A gas in equilibrium with ice is capable of supporting a greater quantity of water vapor at a given temperature than a gas in equilibrium with liquid water. This means that a measurement below  $0\text{ }^{\circ}\text{C}$  ( $+32\text{ }^{\circ}\text{F}$ ) taken over water will read approximately 10% lower than the same measurement taken over ice.

There are two modes of FAST operation, enabling and disabling FAST acts on both modes:

Following DCC: the Optidew makes an initial dew point measurement. If the initial measurement is between  $-3\text{ }^{\circ}\text{C}$  and  $-30\text{ }^{\circ}\text{C}$  ( $+26.6\text{ }^{\circ}\text{F}$  and  $-22\text{ }^{\circ}\text{F}$ ), then the mirror is driven down to below  $-35\text{ }^{\circ}\text{C}$  ( $-31\text{ }^{\circ}\text{F}$ ) to ensure the formation of ice on the mirror surface. The instrument then continues operation as normal.

Dynamic: whenever the measured dew point drops below the value set as 'FAST SetP', the mirror is driven down to below -35 °C (-31 °F) to ensure the formation of ice on the mirror surface. The instrument then continues operation as normal.

Note that Data Hold is active whenever FAST is active.

**NOTE:** Maximum recommended sensor temperatures to enable FAST to reach its required cooling set-point are:

1 Stage Sensor: 21 °C (70 °F)

2 Stage Sensor: 30 °C (86 °F)

For further information, see Section 3.2.

#### 4.4.4. STANDBY Mode

In STANDBY mode, drive to the Peltier heat pump is disabled.

The main use for this feature is during set up (when measurements are not required), i.e. when flow rates are being adjusted and the analog outputs are being configured.

#### 4.4.5. Parameter Conversions & Pressure Compensation

Many parameters which are calculated by the Optidew require a temperature or pressure reading in addition to dew point to ensure the calculated value is correct.

These additional readings can either come from a sensor connected to the Optidew, or from a fixed (manual) input. See Section 3.2 for details on external inputs.

Calculated Parameter	Temperature input required	Pressure input required
%rh	✓	x
wvp	x	x
g/m <sup>3</sup>	✓	x
g/kg	x	✓
Wetbulb	✓	✓
ppmv	x	✓
ppmw	x	✓
%Vol	x	✓

If external sensors are used to generate the inputs, then the sensors should be positioned with so that they are making a measurement representative of the environment seen by the dew-point sensor.

#### 4.4.6. Data Logging

The data logging function allows all of the measured parameters to be logged at a user specified interval on the supplied SD card via the SD card slot on the base or side of the instrument. The filename for each log file is generated automatically from the instrument date and time.

Log files are saved in CSV (comma separated value) format. This allows them to be imported easily into Excel or other programs for charting and trend analysis. To set up data logging refer to Section 3.2.

## 5. WARNINGS AND FAULTS

The Optidew contains a comprehensive self-diagnosis system to alert the user whenever there is an issue which could affect the measurement. These alerts are divided into two categories:

Warnings – A problem which is not currently affecting the measurement but requires attention.

Faults – A problem which requires immediate attention. Whenever a fault is triggered, the Optidew will switch to 'Standby' and remain in this mode until the operator intervenes.

When a Fault is present, the System Alarm symbol will appear over the sensor status display on the main screen. Pressing the System Alarm symbol will display all current faults and warnings. At any other time, active warnings can be viewed by pressing the right-hand side of the sensor status display. A system fault will usually be accompanied by one or more warnings, which describe the problem in more detail.

**Once a fault has been resolved, it is necessary to run a DCC cycle to return the t to normal operation.**

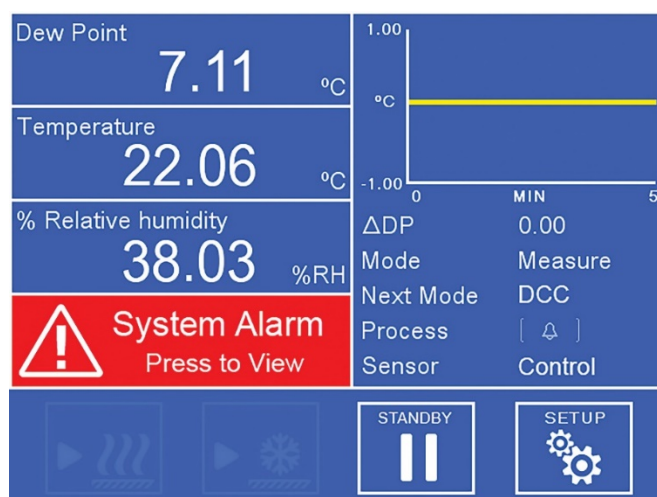

Figure 31 System alarm

For more information on fault codes, please see the next page.

**Possible Fault Codes**

<b>No.</b>	<b>Name</b>	<b>Description</b>
06	Mirror Overheat	Mirror Temperature above 130 °C (266 °F)
02	Optics Fault (Search Fail)	Unable to establish clean mirror condition
03	Optics Fault (< Min Limit)	Signal below allowable limit
04	Optics Fault (> Max Limit)	Signal above allowable limit
08	Heating Saturation	TEC drive saturated in heating mode beyond allowable time limit
09	Cooling Saturation	TEC drive saturated in cooling mode beyond allowable time limit
01	Mirror Pt1000 Fault	Chilled Mirror sensor internal Pt1000 fault
04	Temp. Probe Fault	External temperature probe fault
07	Pressure Tx. Fault	External pressure transmitter fault
17	Mirror Contaminated	Mirror requires cleaning followed by Optics Calibration
11	Mirror Pt1000 Fault (Open)	Chilled Mirror sensor Pt1000 open circuit
12	Mirror Pt1000 Fault (Low)	Chilled Mirror sensor Pt1000 short circuit/below lower limit
13	Mirror Pt1000 Fault (High)	Chilled Mirror sensor Pt1000 above upper limit
08	Temp. Probe Fault (Open)	External temperature probe open circuit
09	Temp. Probe Fault (Low)	External temperature probe short circuit/below lower limit
10	Temp. Probe Fault (High)	External temperature probe above upper limit
14	Pressure Tx. Fault (Open)	Pressure transmitter signal < 0.2 mA (open circuit)
15	Pressure Tx. Fault (Alarm)	Pressure transmitter signal 3.6...3.8 mA, or 20.5...21 mA
16	Pressure Tx. Fault (Fail)	Pressure transmitter signal > 21 mA, or < 3.6 mA

## 6. MAINTENANCE

### 6.1. Mirror Cleaning

Throughout the life of the instrument, periodic cleaning of the mirror surface and optics window may be required. The frequency of this depends upon operating conditions and the potential in the application for contaminants to be deposited on the mirror.

The Optidew will notify the user on the state of mirror contamination. The instrument will initially give a warning in the sensor status display (or as a Magenta/flashing Magenta indication on the transmitter version) when contamination is detected but will continue to operate. Cleaning the mirror, then running a DCC is necessary when this warning is displayed. If the contamination reaches levels which will drastically affect performance, a fault alarm will trip, causing the instrument to switch to standby mode until action is taken.

For remote indication of an optics warning, the process alarm contact can be set to trip whenever the optics warning is active. See Sections 3.2 and 5 for further information.

The cleaning procedure is as follows:

1. Set the instrument to Standby
2. If mounted in a sample block, disconnect the sensor cable and remove the sensor from the block.
3. Clean the mirror surface and optics window firstly with a cotton bud/Q-Tip soaked in distilled water, then with one of the following solvents: methanol, ethanol, or isopropyl alcohol. To avoid damage to the mirror surface do not press too firmly on the cotton bud/Q-Tip when cleaning. Allow the cleaning solvent to fully evaporate.
4. Finally, clean the mirror again using a fresh cotton bud moistened with distilled water. This last step is necessary to remove any dry residue left by the alcohol and is an important part of the cleaning process.
5. Press the 'Calibrate Optics' button in the 'Alarms' screen. For the Optidew 501 Transmitter without display, refer to Section 3.3.1 (Optics Calibration).



Figure 32 Sensor Cleaning



**WARNING: Do not attempt to remove the sensor potting from the mirror during cleaning (as shown in Figure 32, right-hand picture)**

## 6.2. Exchanging Sensors

It is recommended to keep the dew-point sensor with the control unit that it was originally ordered with. However, if it is necessary to replace the sensor or exchange it for a spare, there are two steps which need to be taken.

1. Connect to the control unit via the application software and click the 'Enter Sensor Configuration' button at the Main Options window and enter the password 7316Sens.
2. Enter the 12 character configuration code found on the calibration certificate for the sensor you are connecting. Connect the new sensor, then navigate to the 'Alarms' screen, and press the 'Calibrate Optics' button. A DCC will follow, which cannot be cancelled. Do not disconnect the sensor during this time.

# Appendix A

## Technical Specifications

## Technical Specifications

<b>Performance</b>			
Dew Point Measurement Accuracy	±0.15 °C (±2.7 °F)		
Repeatability	±0.05 °C (±0.09 °F)		
Sensitivity	±0.01 °C (±0.02 °F)		
Response	Stable measurement at +10 °C (+50 °F) dp within 1 minute		
<b>Dew-Point Sensor</b>			
<b>Sensor</b>	<b>Single Stage</b>	<b>Dual Stage</b>	<b>Harsh Environment</b>
Dew Point Range (°C)	-25...+90	-40...+90	-40...+120
Temperature Range (°C)	-40...+90	-40...+90	-40...+120
%rh Range @ 23 °C	2.25...100	0.45...100	0.45...100
Material	POM (head) Aluminium (body)	POM (head) Aluminium (body)	PEEK (head) Aluminium (body)
Corrosion & Saturation Protection	Active Component Isolation System		
Mirror Temperature Measurement	Pt1000, Class A		
Recommended Sample Flow	Ambient (environmental measurements) to 2 NI/min (flowing sample)		
Pressure	2500 kPag max		
Process connection	M36 x 1.5...6 g		
<b>Remote PRT</b>			
Temperature Measurement Accuracy	±0.1 °C (±0.18 °F)		
Temperature Measurement	Pt100, Class A		
<b>Cables</b>			
Cable length	0.3, 3, 5, 10 & 20m (0.98, 9.84, 16.4, 32.81 & 65.62ft) lengths available (cables can be combined)		
Sensor cable	Standard: 90 °C (194 °F) max temperature High temperature: 120 °C (248 °F) max temperature		
<b>Remote Pressure Sensor (Optional)</b>			
Pressure Measurement Accuracy	±0.25% FS		
Pressure Measurement Range	0...160 KPa or 0...2500 KPa		

Process Connection	1/8" NPT-M	
<b>Control Unit</b>		
Resolution	1 or 2 decimal places selectable	
Measurement Units	°Cdp or °Fdp Relative humidity - % Absolute humidity - g/m <sup>3</sup> , ppmv, %Vol Mixing Ratio - g/kg Wet Bulb Temperature (Twb) - °C, °F Water Vapor Pressure (wvp) - Pa Ambient Temperature - °C, °F pressure converted DP - °C, °F pressure - KPa, Bara, Barg, Psia, Psig	
<b>Enclosure</b>	<b>Wall Mount</b>	<b>Bench Top</b>
Material	ABS	ABS
Analog Outputs	Two mA outputs, selectable 0...20, 4...20 (maximum load 500Ω)	Two mA outputs, selectable 0...20, 4...20 (maximum load 500Ω)
Digital Communications	Modbus RTU over RS485 Modbus TCP over Ethernet (optional)	Modbus RTU over USB & RS485 Modbus TCP over Ethernet (optional)
Alarms	1x Process Relay, 1x Alarm Relay, Both Form C, 1 A, 30 V DC	1x Process Relay, 1x Alarm Relay, Both Form C, 1 A, 30 V DC
Inputs	4...20 mA for pressure sensor	4...20 mA for pressure sensor
Data Logging	SD card slot (optional)	SD card slot
Ingress Protection	IP54 IP65 (optional)	IP54
Dimensions	220 x 175 x 75 mm (8.66 x 6.89 x 3")	220 x 175 x 118 mm (8.66 x 6.89 x 4.65")
Weight	Control unit: 1.5 kg (3.3 lb) Sensor: 200 g (7.05 oz)	Control unit: 1.5 kg (3.3 lb) Sensor: 200 g (7.05 oz)
Display	Analyzer 5.7" color touch screen Transmitter Status LED	5.7" color touch screen
Environmental Conditions	-20...+50 °C (-4 °F...+122 °F), up to 100 %rh non-condensing or 100 %rh condensing with IP65 version	
Supply Voltage	100...240 V AC, 50...60 Hz	
Power consumption	30 VA max	

# Appendix B

## Modbus Register Map

## Modbus Register Map

All the data values relating to the Optidew are stored in 16-bit wide holding registers. Registers can contain either measured or calculated values (dew-point, temperature, relative humidity etc.), or configuration data (analog output or alarm settings).

### Modbus RTU Implementation

This is a partial implementation of the Modbus RTU Standard with the following codes implemented:

Function Code	Description
3	Read Holding Register
6	Write Holding Register
16	Write Multiple Holding Registers

## Register Types

Data Type	Description
float	IEE754 32-bit single precision floating point, spans 2 16-bit holding registers. First register contains the most significant bits.
uint16	16-bit unsigned integer, can contain options list e.g. 0 = Dew Point, 1 = Temperature.
int16	16-bit signed integer.
boolean	Can be treated like a uint16, where 0 = false/disabled, and 1 is true/enabled.

## Communications

In order to communicate with the instrument over a USB connection, first install the Michell application software which contains a USB->UART bridge driver. The Optidew will then appear in Device Manager as a virtual serial port.

### Serial Port Settings (USB/RS485)

9600 Baud Rate, 8 Data Bits, No Parity, 1 Stop Bit, No Flow Control

### Modbus TCP

If using the Ethernet connection, the instrument uses the Modbus TCP protocol instead of Modbus RTU. Refer to resources online for the key differences.

## Register Address

Dec	Hex	Access	Data Type	Description	Comment
<b>Instrument Information</b>					
0	0000	R W	uint16	Instrument Modbus Address	
2	0002	R	uint32	Instrument Serial MS	
3	0003			Instrument Serial LS	
4	0004	R	uint16	Instrument Firmware Version	
5	0005	R	uint16	Register Map Version	
<b>Measured and Calculated Values</b>					
6	0006	R	float	Dew/Frost point MS	Units = Temperature Unit
7	0007	R		Dew/Frost point LS	
8	0008	R	float	Ambient Temp MS	Units = Temperature Unit
9	0009	R		Ambient Temp LS	
10	000A	R	float	Pressure MS	Units = Pressure Unit
11	000B	R		Pressure LS	
12	000C	R	float	Relative Humidity MS	
13	000D	R		Relative Humidity LS	
14	000E	R	float	ppm (vol) MS	Default = Dry Basis, register 105 for wet basis
15	000F	R		ppm (vol) LS	
16	0010	R	float	ppm (wt.) MS	Mol weight of carrier set in register 108
17	0011	R		ppm (wt.) LS	
18	0012	R	float	Absolute Humidity MS	Units = g/m3
19	0013	R		Absolute Humidity LS	
20	0014	R	float	Mixing Ratio MS	Units = g/kg
21	0015	R		Mixing Ratio LS	
22	0016	R	float	Wet Bulb MS	Units = Temperature Unit
23	0017	R		Wet Bulb LS	

24	0018	R	float	Water Vapor Pressure MS	Units = Pascal
25	0019	R		Water Vapor Pressure LS	
30	001E	R	uint16	Temperature Unit	Set using register 100
				0 = °C 1 = °F	
31	001F	R	uint16	Pressure Unit	Set using register 101
				0=psig 1=psia 2=barg 3=bara 4=kPa	
<b>Instrument Status</b>					
33	0021	R	uint16	Operating Mode	
				5=MaxCool 6=DCC 7=Hold 8=Measure 9=Standby 10=FAST 13=System Failure	
34	0022	R	uint16	Mode Hrs Left	
35	0023	R	uint16	Mode Mins Left	
36	0024	R	uint16	Mode Secs Left	
37	0025	R	uint16	Sensor Status	
				1=Cooling 2=Heating 3=In-Control 4=Idle	
38	0026	R	uint16	Fault Status 1	
				bit0=Optics Search Fail bit1=Optics Min Limit bit2=Optics Max Limit bit3=Ambient Pt100 Fail bit4=Mirror Pt100 Fail bit5=Mirror Overheat bit6=Loop Fail (Pressure Tx) bit7=Heating Saturation bit8=Cooling Saturation	
39	0027	R	uint16	Fault Status 2	

				bit0=Ambient Pt100 Open bit1=Ambient Pt100 Low bit2=Ambient Pt100 High bit3=Mirror Pt100 Open bit4=Mirror Pt100 Low bit5=Mirror Pt100 High bit6=Loop Open (Pressure Tx) bit7=Loop Alarm (Pressure Tx) bit8=Loop Fail (Pressure Tx) bit9=Contaminated	
40	0028	R	uint16	Alarms Status	
				bit0=System bit1=Process	
41	0029	R	uint16	Logging Status	
				0=Not Fitted 1=No Card 2=Ready 3=Logging 4=Writing 5=Mount Error 6=Write Error 7=Mounting 8=Write Protected 9=Unknown	
42	002A	R	boolean	Data Hold Active	
43	002B	R	boolean	Display Hold Active	
50	0032	R	int16	Peltier Drive %	
51	0033	R	uint16	Optics Signal %	
<b>Calculation Parameters</b>					
100	0064	R W	uint16	Set Temp Unit	
				0=°C 1=°F	
101	0065	R W	uint16	Set Pressure Unit	
				0=psig 1=psia 2=barg 3=bara 4=kPa	
103	0067	R W	boolean	%rh - Force Over Water WVP	wvp calculated over water in %rh calculation (not recommended)

104	0068	R W	boolean	%rh - Force Over Water SWVP (WMO standard)	swvp calculated over water in %rh calculation as per WMO standard
105	0069	R W	boolean	ppm(vol) Wet Basis	Use wet basis calculation method
106	006A	R W	float	Atmospheric Pressure MS	Atmospheric pressure used for pressure conversion
107	006B	R W		Atmospheric Pressure LS	
108	006C	R W	float	Mol Weight MS	Carrier gas molecular weight for Mixing Ratio / ppm(wt.), default air
109	006D	R W		Mol Weight LS	
110	006E	R W	boolean	Pressure Correction Enabled	
111	006F	R W	uint16	Pressure Correction Direction	
				0=To atmospheric 1=From atmospheric	
<b>Pressure Sensor Configuration</b>					
112	0070	R W	uint16	Pressure Sensor Source	
				0=External 1=Fixed	
113	0071	R W	uint16	Pressure Sensor Unit	
				0=psig 1=psia 2=barg 3=bara 4=kPa	
114	0072	R W	float	Manual Pressure MS	
115	0073	R W		Manual Pressure LS	
116	0074	R W	float	Pressure Range Low Ma MS	4 mA
117	0075	R W		Pressure Range Low Ma LS	
118	0076	R W	float	Pressure Range High Ma MS	20 mA
119	0077	R W		Pressure Range High Ma LS	
120	0078	R W	float	Pressure Range Low MS	Pressure Sensor Zero
121	0079	R W		Pressure Range Low LS	
122	007A	R W	float	Pressure Range High MS	Pressure Sensor Span
123	007B	R W		Pressure Range High LS	
<b>Temperature Sensor Configuration</b>					
124	007C	R W	uint16	Temperature Sensor Source	

				0=External 1=Fixed	
125	007D	R W	float	Manual Temperature MS	
126	007E	R W		Manual Temperature LS	
<b>Instrument Configuration</b>					
127	007F	R W	uint16	DCC Setpoint Mode	
				0=Absolute 1=Relative	
128	0080	R W	int16	DCC Temperature Setpoint	(Degrees * 100)
129	0081	R W	uint16	DCC Interval Mode	
				0= Manual 1= Auto (Recommended)	
130	0082	R W	uint16	DCC Interval Mins	
131	0083	R W	uint16	DCC Duration Mins	
132	0084	R W	boolean	FAST Enable	
134	0086	R W	float	FAST Setpoint MS	
135	0087	R W		FAST Setpoint LS	
136	0088	R W	uint16	Peltier Stages	
				1=1 Stage 2=2 stage	
137	0089	R W	uint16	Stability Band	(Degrees * 1000) . Threshold to end Data Hold
140	008C	W	uint16	Set Mode	
				1=Standby 2=DCC 4=MaxCool 8=Cancel MaxCool 16=Calibrate Optics	
<b>Display Parameters</b>					
145	0091	R W	uint16	Language	
				0=English 1=German 2=Spanish 3=French 4=Italian 5=Portuguese 6=USA 7=Russian 8=Japanese 9=Chinese	
146	0092	R W	uint16	Decimal Places	

147	0093	R W	uint16	Displayed Parameter 1	
				0=Dew/Frost point 1=Temperature 2=Pressure 3=Relative Humidity 4=ppm(vol) 5=ppm(wt.) 6=Mixing Ratio 7=Absolute Humidity 8=Wet bulb 9=WVP 10=%vol	
148	0094	R W	uint16	Displayed Parameter 2	
149	0095	R W	uint16	Displayed Parameter 3	
150	0096	R W	boolean	Enable Display Hold	
<b>Analog Output Settings</b>					
155	009B	R W	uint16	Analog 1 Type	
				0=0...20 mA 1=4...20 mA	
156	009C	R W	uint16	Analog 1 Parameter	
				0=Dew/Frost point 1=Temperature 2=Pressure 3=Relative Humidity 4=ppm(vol) 5=ppm(wt.) 6=Mixing Ratio 7=Absolute Humidity 8=Wet bulb 9=WVP 10=%vol	
157	009D	R W	float	Analog 1 Range Low MS	
158	009E	R W		Analog 1 Range Low LS	
159	009E	R W	float	Analog 1 Range High MS	
160	00A0	R W		Analog 1 Range High LS	
161	00A1	R W	uint16	Analog 2 Type	
162	00A2	R W	uint16	Analog 2 Parameter	
163	00A3	R W	float	Analog 2 Range Low MS	
164	00A4	R W		Analog 2 Range Low LS	
165	00A5	R W	float	Analog 2 Range High MS	
166	00A6	R W		Analog 2 Range High LS	
167	00A7	R W	uint16	Analog 1 Alarm Type	

		R W		0=None 1=System Only 2=Process Only 3=Both	
168	00A8	R W	uint16	Analogue 2 Alarm Type	
171	00AB	R W	uint16	Process Alarm Parameter	
				0=Dew/Frost point 1=Temperature 2=Pressure 3=Relative Humidity 4=ppm(vol) 5=ppm(wt.) 6=Mixing Ratio 7=Absolute Humidity 8=Wet bulb 9=WVP 10=%vol	
172	00AC	R W	uint16	Process Alarm Type	
<b>Ethernet Settings</b>					
201	00C9	R W	uint16	IP Address 1	Default IP is <b>10.0.50.100</b>  Reading this register causes all IP address, subnet and gateway registers to be updated from Ethernet add-on board
202	00CA	R W	uint16	IP Address 2	<b>10.0.50.100</b>
203	00CB	R W	uint16	IP Address 3	10.0. <b>50</b> .100
204	00CC	R W	uint16	IP Address 4	10.0.50. <b>100</b>
205	00CD	R W	uint16	Subnet Mask 1	<b>255.255.255.0</b>
206	00CE	R W	uint16	Subnet Mask 2	255. <b>255</b> .255.0
207	00CF	R W	uint16	Subnet Mask 3	255.255. <b>255</b> .0
208	00D0	R W	uint16	Subnet Mask 4	255.255.255. <b>0</b>
209	00D1	R W	uint16	Gateway 1	<b>10.0.50.254</b>
210	00D2	R W	uint16	Gateway 2	10. <b>0</b> .50.254
211	00D3	R W	uint16	Gateway 3	10.0. <b>50</b> .254
212	00D4	R W	uint16	Gateway 4	<b>10.0.50.254</b> Writing this register causes all IP address, subnet and gateway

					registers to be written to Ethernet add-on board.
--	--	--	--	--	---

**Further Reading**



<http://www.simplymodbus.ca/FAQ.htm> is an excellent resource covering the basics of the Modbus protocol. Full descriptions of the function codes (FC03/FC06/FC16) can be found in the sidebar.



<https://www.scadacore.com/tools/programming-calculators/online-hex-converter/> is an excellent resource for determining register types/byte order issues in raw received Modbus data.

# Appendix C

## Legacy Serial Protocol

## C.1 Legacy Mode

Legacy serial mode enables backward compatibility with **Dewmet TDH** and **Optidew 1** serial protocols using either RS485 or USB.

Neither of these is a full RS232 compatible port so legacy mode emulates the protocol but has some missing features:

- No RS232 control lines.
- No echoing of characters.
- Packets are handled half-duplex, so sending a command to the instrument while it is transmitting will result in the instrument ignoring the command and the PC side receiving corrupt data.

Only a small subset of commands are implemented for reading data, many of the setup commands used on legacy instruments are not meaningful in the context of Optidew 401-501.

Where a read value is not available on the Optidew 401-501 a replacement value is formatted to appear identical; see Section C.4 (Emulated Legacy Commands) for more details.

***RS485 and USB share the same buffer in legacy mode and should not be used at the same time.***

### 1.1 Serial Settings

Baud Rate	9600
Data Bits	8
Stop Bits	1
Parity	None
Flow Control	None

## C.2 Hardware Connection

### 2.1 RS232

An RS485 to RS232 converter can be used to make the Optidew 401-501 backwards compatible with an existing RS232 connection, the converter has to handle transmit/receive switching automatically and in a timeframe suitable for normal Modbus operation.

### 2.2 USB

The Optidew 401-501 USB expansion port can be used with a PC, this appears as a virtual serial port and should work with any software written to use a serial port providing it does not send and receive data at the same time as the instrument still processes this as if it was a half-duplex connection.

### C.3 Changing between Modbus and Legacy Mode

#### 3.1 Changing to Legacy mode

##### 3.1.1 Using Modbus

Write the value "737" to Modbus register address "450".

##### 3.1.2 Using the display

The service code "53161" can be entered into the display to switch to legacy mode.

**NOTE:** After either of these methods Modbus will cease to function, the display or a legacy serial command must be used to re-enable Modbus.

#### 3.2 Changing to Modbus mode

##### 3.2.1 Using legacy commands

Enter the command "*modbus=1* <CR>" (<CR> being carriage return).

##### 3.2.2 Using the display

The service code "53160" can be entered into the display to switch to Modbus mode.

**NOTE:** After either of these methods Legacy mode will cease to function, the display or Modbus commands must be used to re-enable legacy mode

## C.4 Emulated Legacy Commands

### 4.1 Optidew 1

"Y" or "y"

Returns a single status report with the following format.

":050714980344012405892116160897201<cr><lf>"

Position	Example	Description
1	:	Fixed start character
2-5	0507	Dew Point * 10, 0507 = 50.7 degrees Negative values have +8000 added, 7999 = -0.1 degrees
6-9	1498	Ambient Temperature * 10, 1498 = 148.9 degrees Negative values have +8000 added, 7999 = -0.1 degrees
10-13	0344	Relative Humidity * 10, 0344 = 34.3%
14-17	0124	[DIFFERS FROM ORIGINAL PROTOCOL DUE TO OPTICS BALANCE] Signal Level – now film thickness 0000 = 000% = No film 0100 = 100% = Correct level of film for control 0200 = 200% = double film or higher
18-21	0589	Heat pump drive 0 = heating mirror at 100% drive 450 = 0% drive, not heating or cooling mirror 1023 = cooling mirror at 100% drive
22	2	Instrument Status 0 = DCC, 1 = Output is held, 2 = measure, 3 = system alarm, 4 = process alarm New status values 5 = Standby, 6 = FAST, 7 = System Failure, 8 = Max Cool
23-27	11616	G/M3 * 100, 11616 = 116.16
28-32	08972	G/Kg * 100, 08972 = 89.72
33	0	Temperature unit, 0=°C, 1=°F
34	1	Sensor status, 0 = cooling, 1 = control, 2 = heating
35	<cr><lf>	Carriage return and line feed

#### 4.1.2 "X" or "x"

Begins sending status reports (see command "Y" above) every second until a stop command is received (see "S7" below).

#### 4.1.3 "ST" or "st"

Stops the automatic sending of status reports (see command "X" above).

#### 4.1.4 "ABC" or "abc"

Initiates a DCC, Optidew 401-501 features that occur as part of a DCC cycle, such as DCC Plus and FAST operate as normal.

#### 4.1.5 "GDP" or "gdp"

Returns a single report of Dew Point in the following format:

```
"101.2<CR><LF>"
```

#### 4.1.6 "GTP" or "gtp"

Returns a single report of temperature in the following format:

```
"23.4<CR><LF>"
```

#### 4.1.7 "GRH" or "grh"

Returns a single report of relative humidity in the following format:

```
"42.5<CR><LF>"
```

## 4.2 Dewmet TDH

### 4.2.1 "TDH" or "tdh"

Returns a single status report with the following format:

```
"12.3_Cdp__45.6_%RH__78.9_degC<CR><LF>"
```

"\_" in the example above are space characters that have been replaced to make it easy to see the formatting.

Value	Description
12.3	Dew Point to 1 decimal place
C	Temperature unit, °C or °F
45.6	Relative Humidity to 1 decimal place
78.9	Ambient temperature to 1 decimal place
C	Temperature unit, °C or °F
<CR><LF>	Carriage return and line feed

**NOTE:** The values output by this command are only updated when the instrument is not in output hold.

**On boot up the values are set to:**

**Dew Point = 0.0**

*%rh = 100.0*

*Temperature = -100.0*

*As the instrument boots in output hold, these values will not change until after the first output hold period ends.*

## **C.5 New Commands for Optidew 401-501**

### **5.1 "RST" or "rst"**

Initiates an optics reset, features that normally operate as part of an optics reset such as DCC, FAST etc will operate as normal.

Returns "OK<CR><LF>".

### **5.2 "modbus=1"**

Changes the instrument serial mode to Modbus, this is saved in non-volatile storage and persists after the instrument is switched off.

**NOTE:** Legacy commands will cease working immediately after this command, a Modbus command or the display must be used to re-enable legacy mode.

### **5.3 "DCC" or "dcc"**

Initiates a DCC, features that occur as part of a DCC cycle, such as DCC Plus and FAST operate as normal.

Returns "OK<CR><LF>".

### **5.4 "IDD" or "idd"**

Returns the instrument model ID in the format "ID=42241<CR><LF>".

The "Optidew 401-501" always returns "42241".

### **5.5 "VER" or "ver"**

Returns the firmware version in the format "V1.010<CR><LF>" for version 1.01.

### **5.6 "SER" or "ser"**

Returns the instruments serial number in the format "#0000123<CR><LF>".

# Appendix D

## Dimensional Drawings

### Dimensional Drawings

#### Optidew 401 Bench Top analyzer

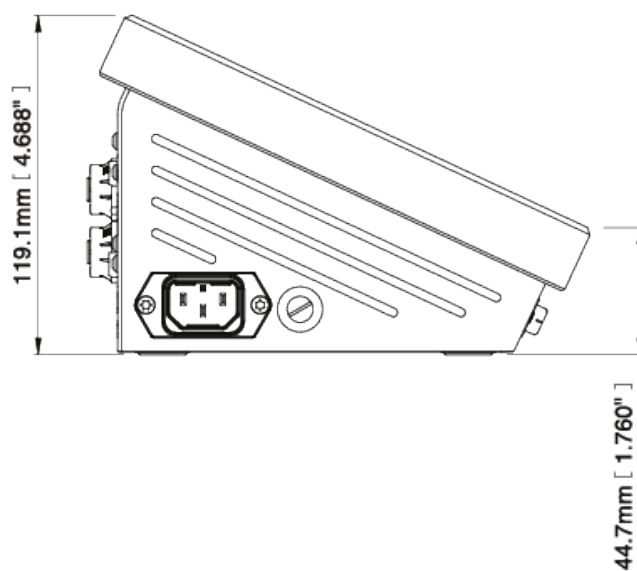
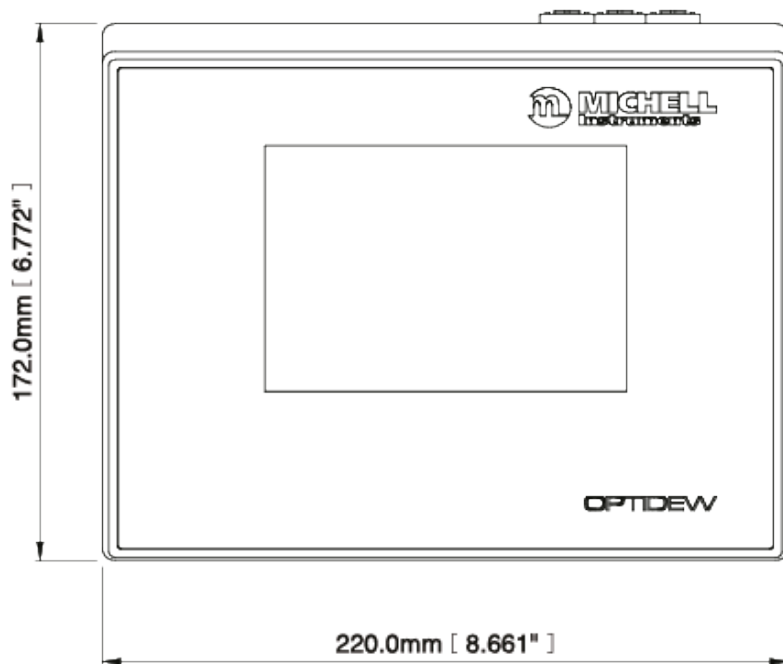

**Optidew 501 Wall Mount Analyzer – IP54**

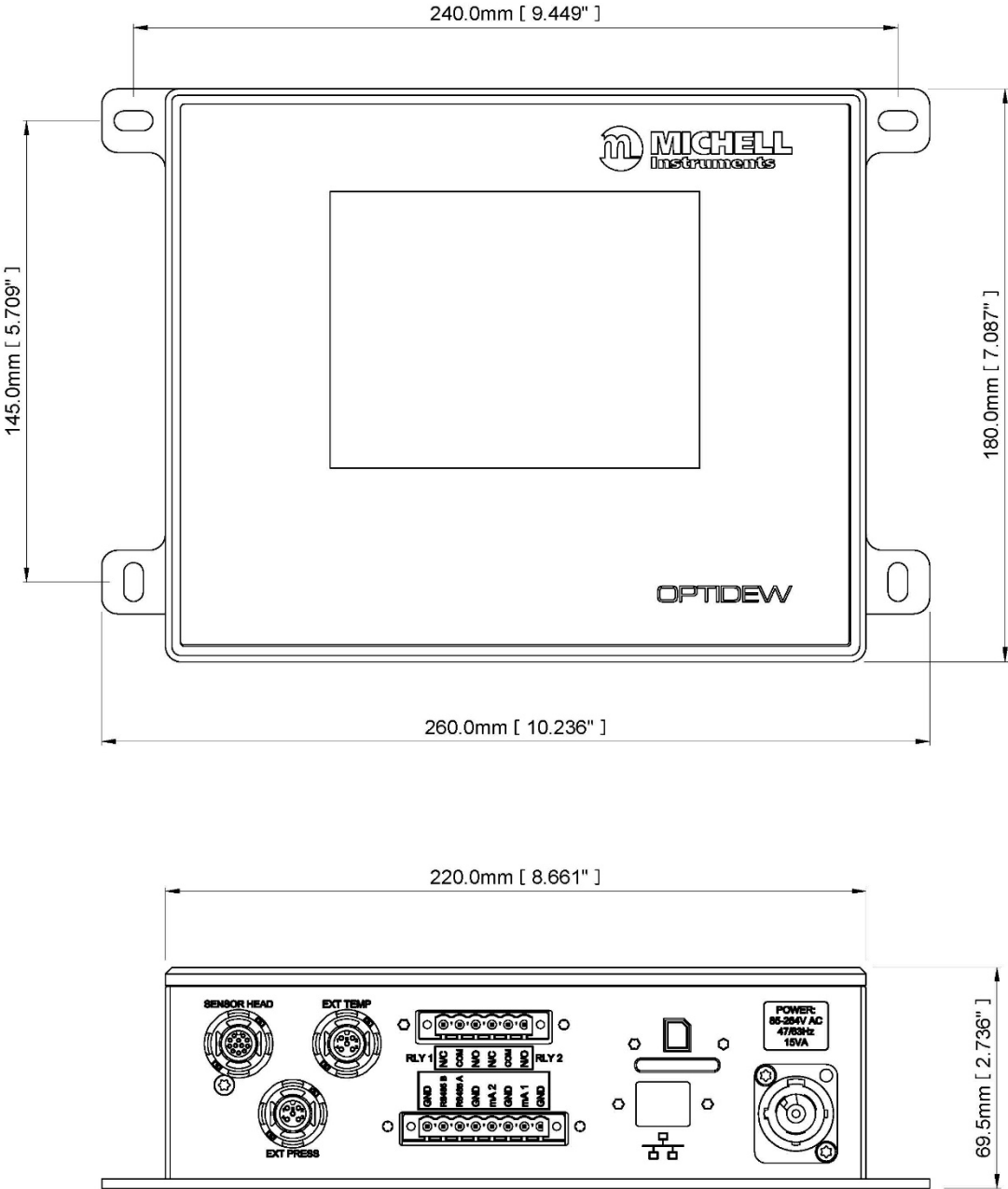

**Optidew 501 Wall Mount Transmitter – IP65**

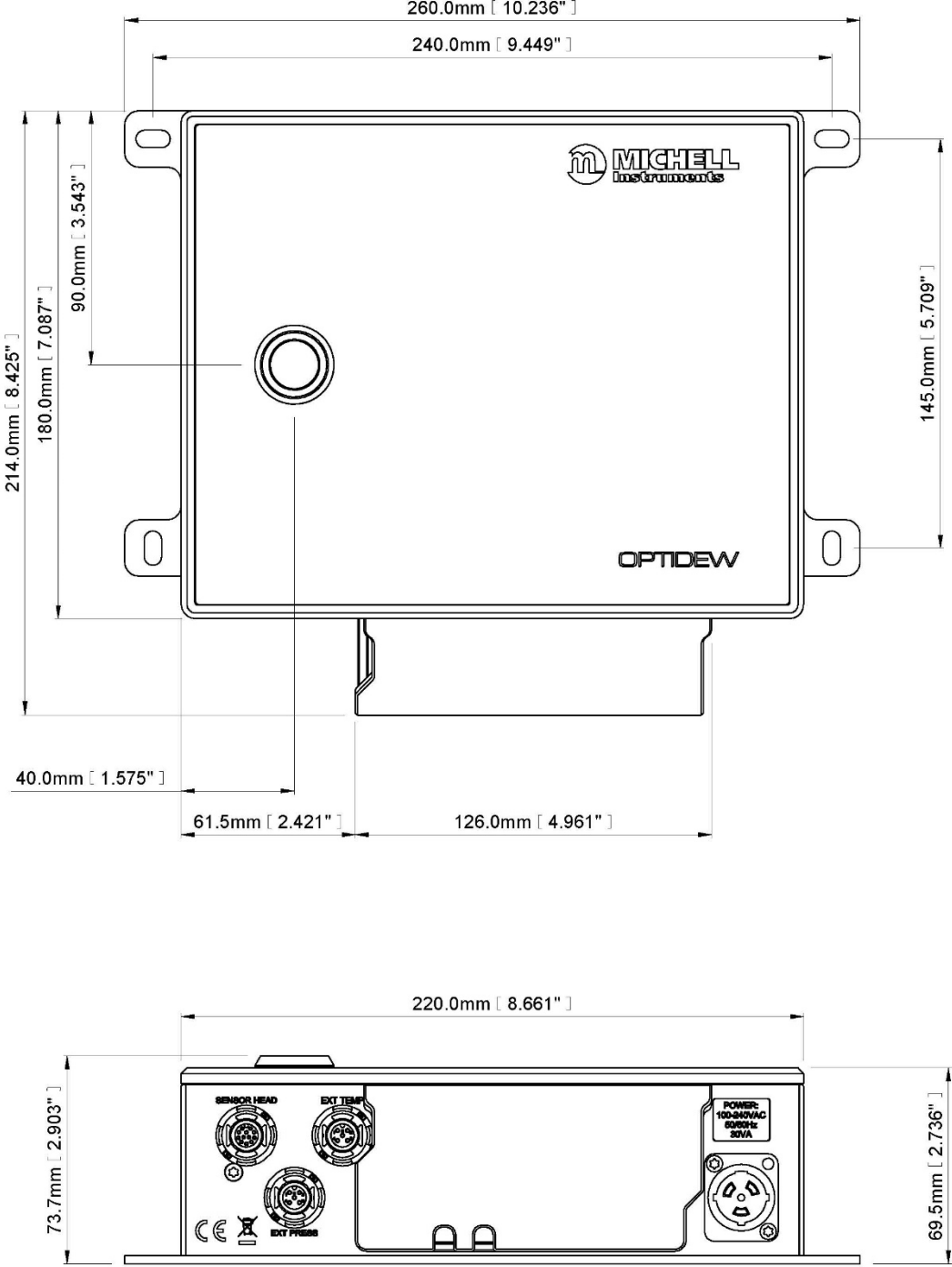

Single Stage Dew-Point Sensor

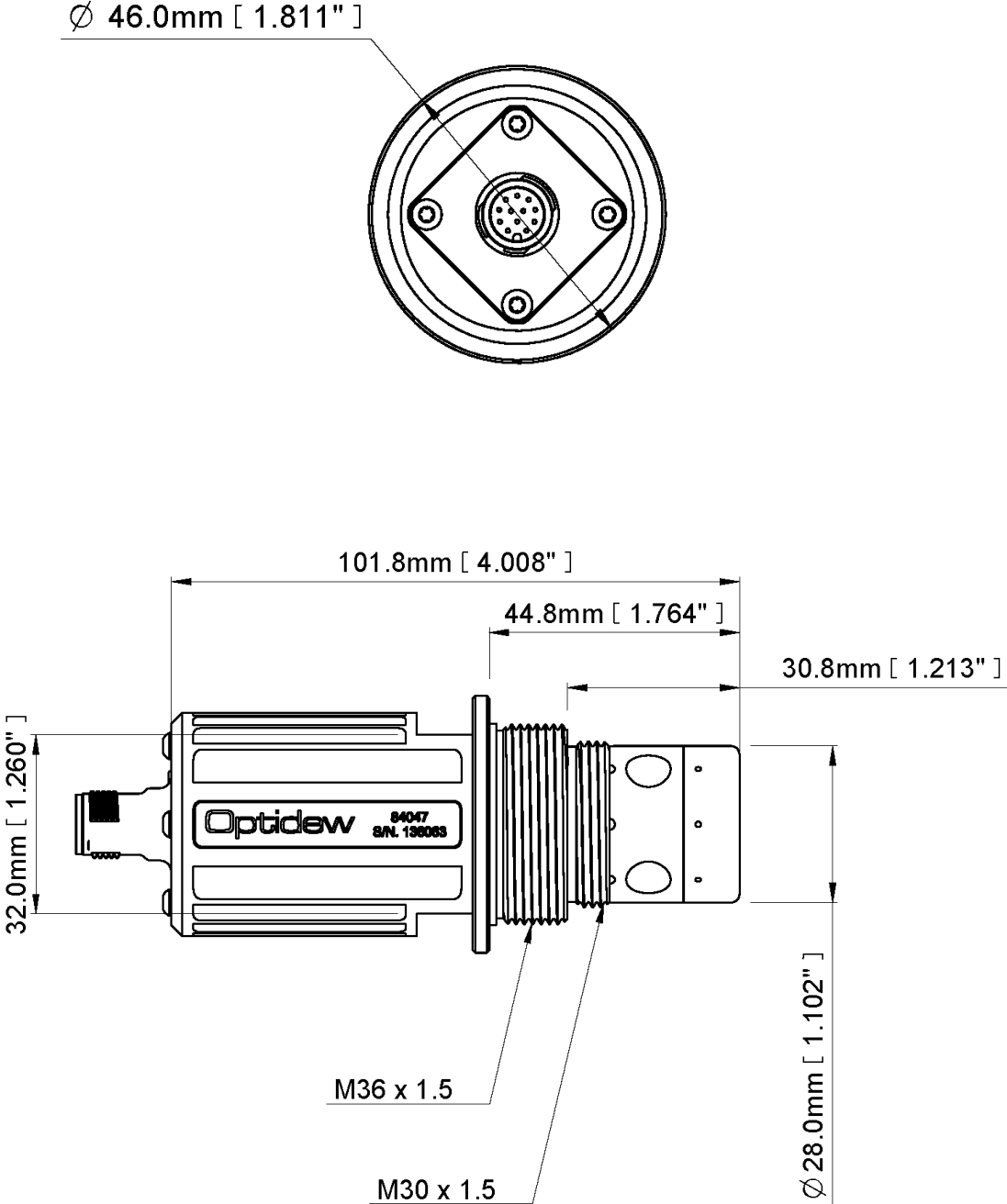

Dual Stage Dew-Point Sensor

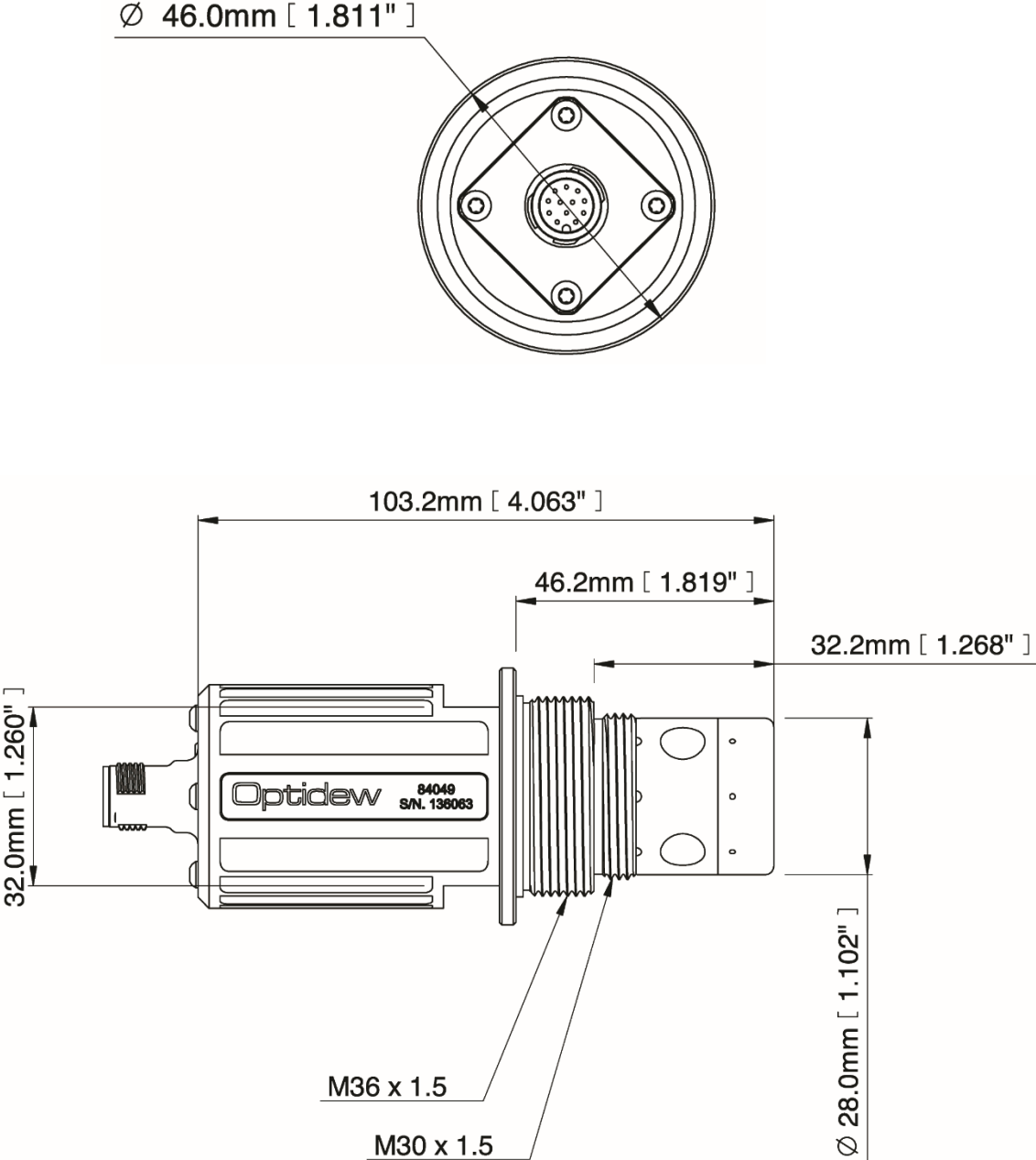

Sample Block

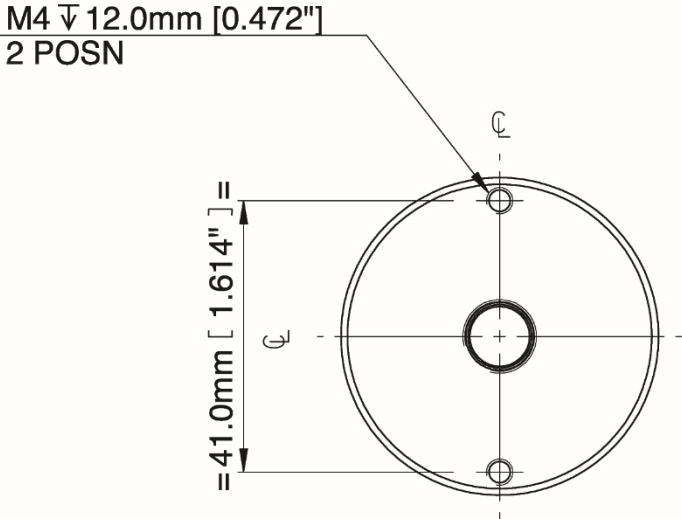
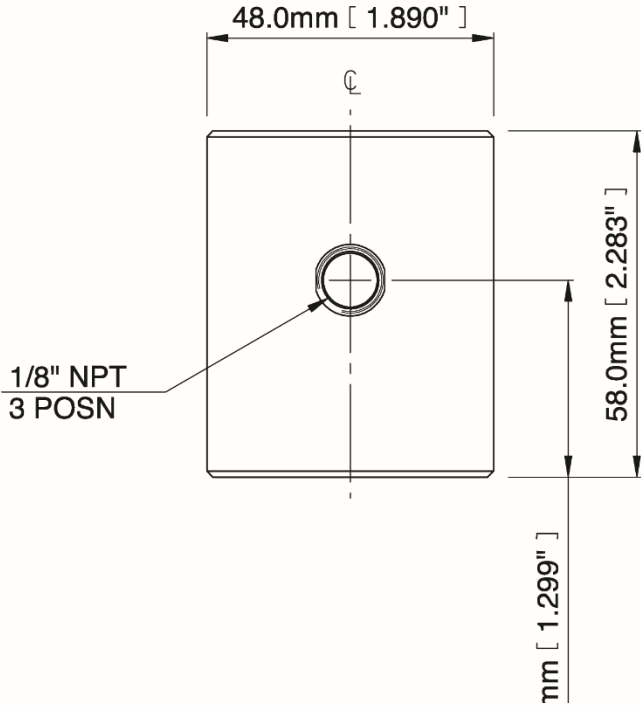

**Standard Temperature Probe**

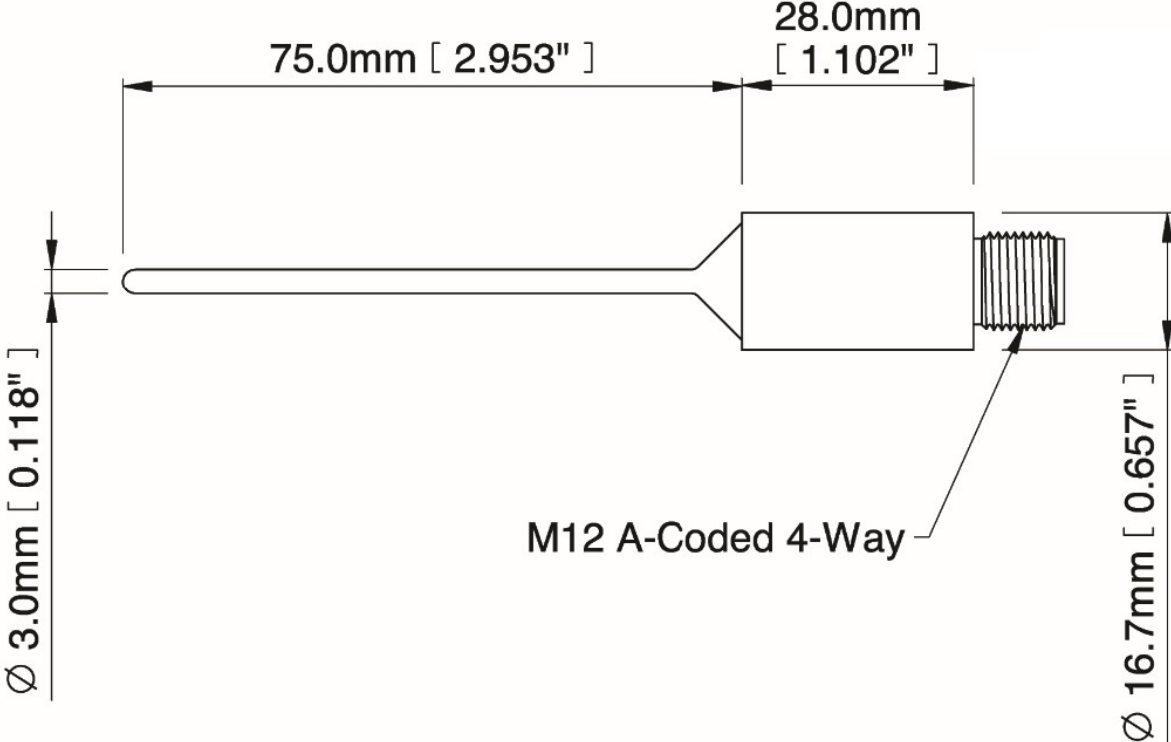

\*Weld burr may extend from 1 mm (0.04") from colar to towards tip of probe.  
Probe and connector rated 90 °C (194 °F).

**High Temperature Probe**



Maximum temperature measurement 120 °C (248 °F).  
Connector rated 120 °C (248 °F).  
Probe and cable rated 250 °C (482 °F).

# Appendix E

## Quality, Recycling & Warranty Information

## **Quality, Recycling, Compliance & Warranty Information**

Michell Instruments is dedicated to complying to all relevant legislation and directives. Full information can be found on our website at:

**[www.michell.com/compliance](http://www.michell.com/compliance)**

This page contains information on the following directives:

- Anti-Facilitation of Tax Evasion Policy
- ATEX Directive
- Calibration Facilities
- Conflict Minerals
- FCC Statement
- Manufacturing Quality
- Modern Slavery Statement
- Pressure Equipment Directive
- REACH
- RoHS3
- WEEE2
- Recycling Policy
- Warranty and Returns

# Appendix F

## Return Document & Decontamination Declaration

## Return Document & Decontamination Declaration



### Decontamination Certificate

**IMPORTANT NOTE: Please complete this form prior to this instrument, or any components, leaving your site and being returned to us, or, where applicable, prior to any work being carried out by a Michell engineer at your site.**

Instrument			Serial Number	
Warranty Repair?	YES	NO	Original PO #	
Company Name			Contact Name	
Address				
Telephone #			E-mail address	
Reason for Return /Description of Fault:				
Has this equipment been exposed (internally or externally) to any of the following? Please circle (YES/NO) as applicable and provide details below				
Biohazards			YES	NO
Biological agents			YES	NO
Hazardous chemicals			YES	NO
Radioactive substances			YES	NO
Other hazards			YES	NO
Please provide details of any hazardous materials used with this equipment as indicated above (use continuation sheet if necessary)				
Your method of cleaning/decontamination				
Has the equipment been cleaned and decontaminated?			YES	NOT NECESSARY
Michell Instruments will not accept instruments that have been exposed to toxins, radio-activity or bio-hazardous materials. For most applications involving solvents, acidic, basic, flammable or toxic gases a simple purge with dry gas (dew point <-30°C) over 24 hours should be sufficient to decontaminate the unit prior to return. <b>Work will not be carried out on any unit that does not have a completed decontamination declaration.</b>				
<b>Decontamination Declaration</b>				
I declare that the information above is true and complete to the best of my knowledge, and it is safe for Michell personnel to service or repair the returned instrument.				
Name (Print)			Position	
Signature			Date	



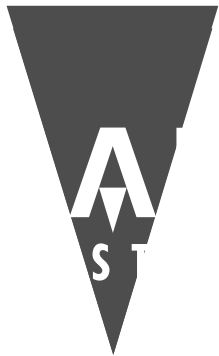

**Lauper Instruments AG**

Irisweg 16 B

CH-3280 Murten

Tel. +41 26 672 30 50

[info@lauper-instruments.ch](mailto:info@lauper-instruments.ch)

[www.lauper-instruments.ch](http://www.lauper-instruments.ch)



**MICHELL**  
**Instruments**

A PST BRAND